

Two-colour patterns of synchrony in lattice dynamical systems

Yunjiao Wang and Martin Golubitsky

Department of Mathematics, University of Houston, Houston, TX 77204-3008, USA

Received 11 June 2004, in final form 14 October 2004

Published 6 December 2004

Online at stacks.iop.org/Non/18/631

Recommended by J Lega

Abstract

Using the theory of coupled cell systems developed by Stewart, Golubitsky, Pivato and Török, we consider patterns of synchrony in four types of planar lattice dynamical systems: square lattice and hexagonal lattice differential equations with nearest neighbour coupling and with nearest and next nearest neighbour couplings. *Patterns of synchrony* are flow-invariant subspaces for all lattice dynamical systems with a given network architecture that are formed by setting coordinates in different cells equal. Such patterns can be formed by symmetry (through fixed-point subspaces), but many patterns cannot be obtained in this way. Indeed, Golubitsky, Nicol and Stewart present patterns of synchrony on square lattice that are not predicted by symmetry. The general theory shows that finding patterns of synchrony is equivalent to finding balanced equivalence relations on the set of cells. In a two-colour pattern one set of cells is coloured white and the complement black. Two-colour patterns in lattice dynamical systems are *balanced* if the number of white cells connected to a white cell is the same for all white cells and the number of black cells connected to a black cell is the same for all black cells. In this paper, we find all two-colour patterns of synchrony of the four kinds of lattice dynamical systems, and show that all of these patterns, including spatially complicated patterns, can be generated from a finite number of distinct patterns. Our classification shows that all balanced two-colourings in lattice systems with both nearest and next nearest neighbour couplings are spatially doubly periodic. We also prove that equilibria associated with each such two-colour pattern can be obtained by codimension one synchrony-breaking bifurcation from a fully synchronous equilibrium.

Mathematics Subject Classification: 34C99, 37G99, 82B20

(Some figures in this article are in colour only in the electronic version)

1. Introduction

Stewart, Golubitsky, Pivato and Török [9, 10] formalize the concept of a *coupled cell system*. A *cell* is a system of ODE. A *coupled cell system* consists of cells whose equations are coupled. Stewart *et al* define the architecture of coupled cell systems and develop the theory that shows how network architecture leads to synchrony. The architecture of a coupled cell system is a graph that indicates which cells have the same phase space, which cells are coupled to which, and which couplings are the same.

The *input set* $I(c)$ of a cell c consists of all cells coupled to c . Two input sets are *isomorphic* if there is a bijection between the input sets that preserves coupling types. A coupled cell network is *homogeneous* if the input sets of all cells are isomorphic.

A lattice dynamical system is a homogeneous coupled cell system with cells indexed by a lattice \mathcal{L} . Such a system has the form

$$\dot{x}_c = g(x_c, x_{I(c)}) \quad c \in \mathcal{L}, \quad (1.1)$$

where $x_c \in \mathbf{R}^n$, $I(c) = \{c_1, \dots, c_k\}$, $x_{I(c)} = (x_{c_1}, \dots, x_{c_k}) \in (\mathbf{R}^n)^k$ and $g : (\mathbf{R}^n)^{k+1} \rightarrow \mathbf{R}^n$.

Specifically, a *square lattice dynamical system with nearest neighbour coupling* has the form

$$\dot{x}_{i,j} = g(x_{i,j}, \overline{x_{i+1,j}, x_{i-1,j}, x_{i,j+1}, x_{i,j-1}}), \quad (1.2)$$

where $(i, j) \in \mathbf{Z}^2$, $x_{i,j} \in \mathbf{R}^n$, and g is invariant under all permutations of the variables under the bar. A *square lattice dynamical system with nearest and next nearest neighbour couplings* has the form

$$\dot{x}_{i,j} = g(x_{i,j}, \overline{x_{i+1,j}, x_{i-1,j}, x_{i,j+1}, x_{i,j-1}, x_{i+1,j+1}, x_{i-1,j+1}, x_{i+1,j-1}, x_{i-1,j-1}}). \quad (1.3)$$

A picture of the cells that are coupled to cell (i, j) is given in figure 1(a).

Let the hexagonal lattice be $\{il_1 + jl_2 : i, j \in \mathbf{Z}\}$, where $l_1 = (0, 1)$ and $l_2 = (\frac{1}{2}, \frac{\sqrt{3}}{2})$. A *hexagonal lattice dynamical system with nearest neighbour coupling* has the form

$$\dot{x}_{i,j} = g(x_{i,j}, \overline{x_{i-1,j}, x_{i+1,j}, x_{i,j-1}, x_{i,j+1}, x_{i-1,j+1}, x_{i+1,j-1}}), \quad (1.4)$$

where $x_{i,j}$ denotes the coordinate of the cell at the $il_1 + jl_2$ lattice site. The form of a *hexagonal lattice dynamical system with nearest and next nearest neighbour couplings* is given by

$$\dot{x}_{i,j} = g(x_{i,j}, \overline{x_{i-1,j}, x_{i+1,j}, x_{i,j-1}, x_{i,j+1}, x_{i-1,j+1}, x_{i+1,j-1}, x_{i-1,j+2}, x_{i-2,j+1}, x_{i-1,j-1}, x_{i+1,j-2}, x_{i+2,j-1}, x_{i+1,j+1}}). \quad (1.5)$$

A picture of the cells that are coupled to cell (i, j) is given in figure 1(b).

A *polydiagonal* is a subspace of the phase space of a coupled cell network that is defined by equality of cells coordinates.

Definition 1.1. A polydiagonal Δ is *robustly polysynchronous* if Δ is flow invariant for every coupled cell system with the given network architecture.

For example, consider the square lattice with nearest neighbour coupling, and let

$$\Delta = \{x : x_{i,j} = x_{k,l} \text{ if } i \equiv k \pmod{2}\}. \quad (1.6)$$

It is straightforward to check that this polydiagonal Δ is flow invariant and hence robustly polysynchronous. Let $x_{i,j} = y$ if i is even and $x_{i,j} = z$ if i is odd. Then the system of differential equations (1.2) has the form

$$\dot{x}_{i,j} = \begin{cases} g(y, \overline{z, z, y, y}) & \text{if } i \text{ is even,} \\ g(z, \overline{y, y, z, z}) & \text{if } i \text{ is odd.} \end{cases}$$

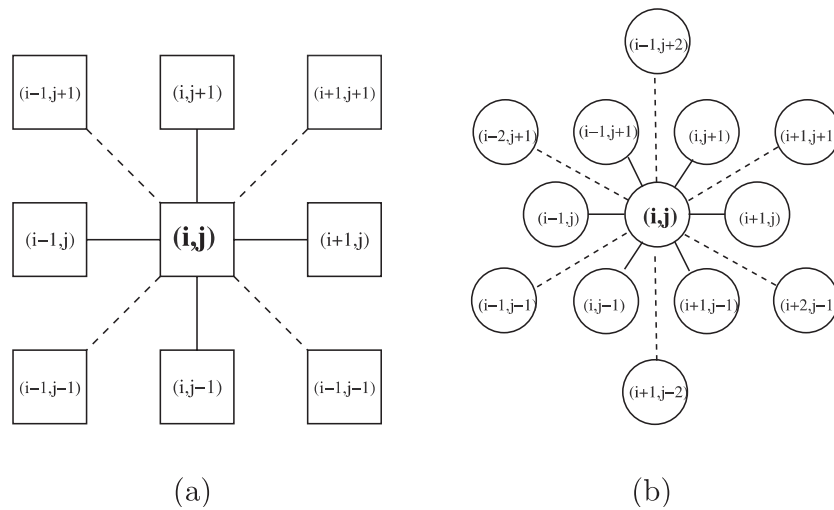

Figure 1. The nearest neighbour cells of cell (i, j) are the cells that are connected with the cell by solid lines, and next nearest neighbour cells are the cells that are connected with the cell by dashed lines: (a) square lattice; (b) hexagonal lattice.

These equations are identical for all even i and for all odd i ; hence Δ is flow invariant for all g . Robustly polysynchronous polydiagonals are identified with *patterns of synchrony*. For example, the pattern of synchrony associated with the polydiagonal Δ defined in (1.6) is illustrated in figure 3 case 22.

Definition 1.2. In a homogeneous network a two-colouring is *balanced* if each black cell receives the same number of inputs from black cells of each coupling type and each white cell receives the same number of inputs from white cells of each coupling type.

The two-colouring associated with the polydiagonal Δ defined in (1.6) is balanced, since each black cell has two black inputs and each white cell has two white inputs. In this paper, we classify balanced patterns as follows: case ij corresponds to patterns in which each black cell has i white inputs, and each white cell has j black inputs. So Δ is a case 22 pattern.

Stewart *et al* [10, theorem 6.1] prove that a polydiagonal is robustly polysynchronous if and only if the colouring given by colouring cells that have the same coordinates with the same colour is balanced. Following this result, we see that classifying robustly polysynchronous polydiagonals is equivalent to classifying balanced colourings.

Some patterns of synchrony can be predicted by symmetry, namely, those that correspond to fixed-point subspaces of the group of network symmetries. For example, the symmetry group of the square lattice is generated by the horizontal translation $h(i, j) = (i, j + 1)$, the vertical translation $v(i, j) = (i + 1, j)$, and $r(i, j) = (-j, i)$, rotation counterclockwise through 90° . Let Σ be any subgroup of the group of symmetries. Then

$$\text{Fix}(\Sigma) = \{x : \sigma x = x \forall \sigma \in \Sigma\}$$

is well known to be a flow-invariant subspace [8]. Observe that the polydiagonal Δ defined in (1.6) is a fixed-point subspace, namely, $\Delta = \text{Fix}(h)$.

However, not all patterns of synchrony can be obtained as fixed-point subspaces, and some of these nonsymmetric patterns are quite interesting. Golubitsky *et al* [5] give an infinite class of two-colour patterns of synchrony on square lattice dynamical systems with nearest

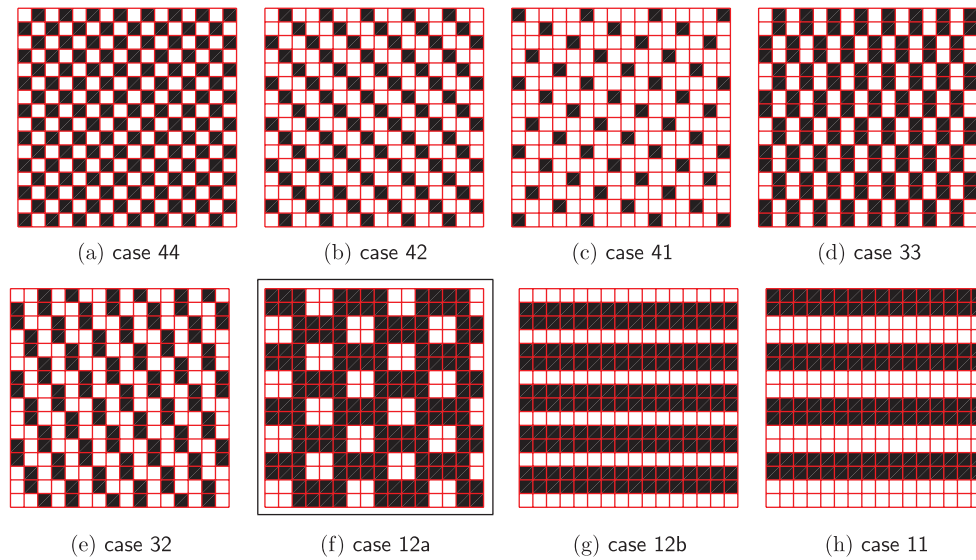

Figure 2. Illustrations of patterns of synchrony of finite classes in 16×16 periodic array.

neighbour coupling, only two of which are fixed-point subspaces. We extend this result by presenting, up to symmetry, all possible two-colour patterns of synchrony of the four kinds of lattice differential equations. These classification results are stated in theorems 1.3, 1.5, 1.7 and 1.9. It follows from these theorems that with both nearest and next nearest neighbour couplings, all balanced two-colourings are spatially doubly periodic.

We also prove that equilibria associated with each such pattern can be obtained by a codimension one synchrony-breaking bifurcation from a fully synchronous equilibrium. See section 2. Recall that the group of symmetries of a lattice is generated by translations within the lattice and rotations and reflections that preserve the lattice.

Main results. We enumerate all balanced two-colourings for the square and hexagonal lattices with nearest neighbour coupling in theorems 1.3 and 1.7. There are two (resp. three) infinite continuum families in the square (resp. hexagonal) lattice and eight (resp. 10) isolated patterns. Remarkably, when next nearest neighbour coupling is also included, then the infinite families disappear and there are 12 (resp. 13) balanced two-colourings in square (resp. hexagonal) lattice differential equations. See theorems 1.5 and 1.9. Moreover, each balanced two-colouring with next nearest neighbour coupling is spatially doubly periodic.

Theorem 1.3. *There are eight two-colour periodic patterns of synchrony of square lattice differential equations with nearest neighbour coupling shown in figure 2. There are two infinite families of two-colour patterns of synchrony that are generated from the periodic patterns in figure 3 by interchanging black and white on diagonals along which black and white cells alternate. Up to symmetry, these are all of the two-colour patterns of synchrony.*

Remark 1.4. All patterns in figure 2 are doubly periodic and the repeating patterns associated with these patterns are given in figure 4. The patterns marked by the boxes in this section are not predicted by symmetry. Figure 5 contains some examples that can be obtained from the patterns in figure 3 by interchanging black and white along certain diagonals. In particular, patterns (b) and (d) are spatially complicated.

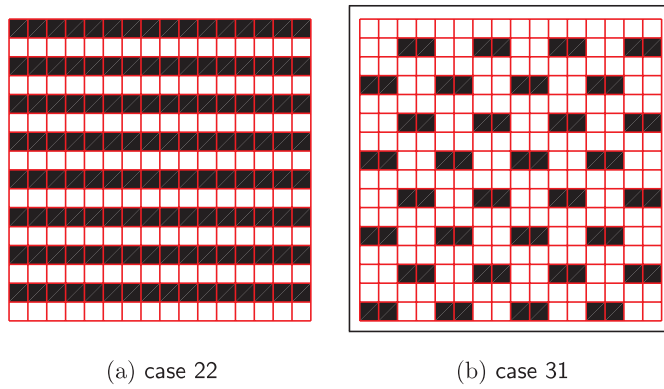

Figure 3. Illustrations of patterns of synchrony of infinite classes in 16×16 periodic array.

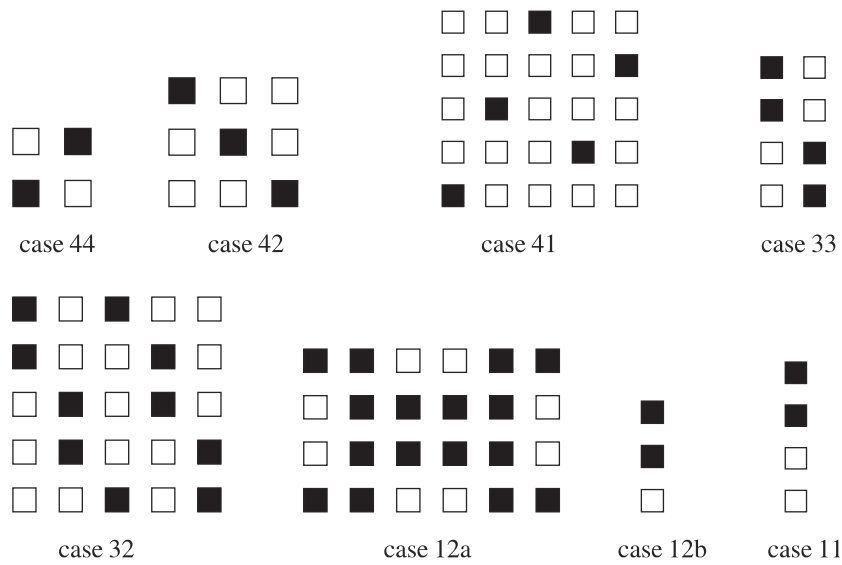

Figure 4. Repeating patterns for finite classes of patterns of synchrony shown in figure 2.

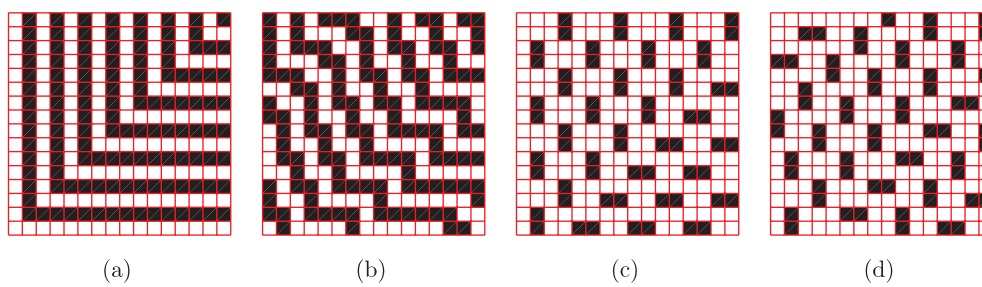

Figure 5. The patterns of synchrony that cannot be expected by symmetry.

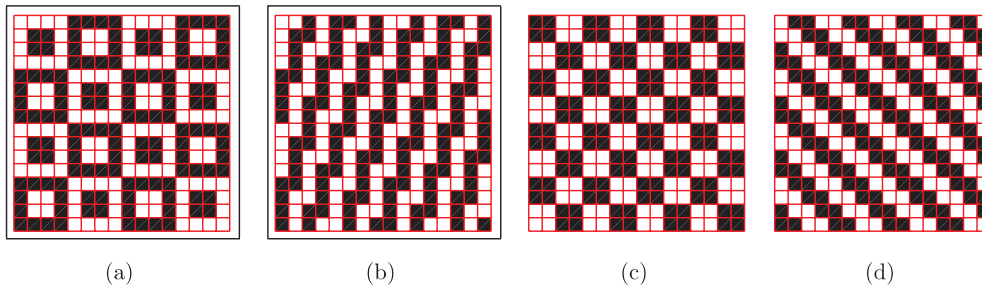

Figure 6. The four patterns in this figure and figure 3(a) are NN-balanced in infinite classes.

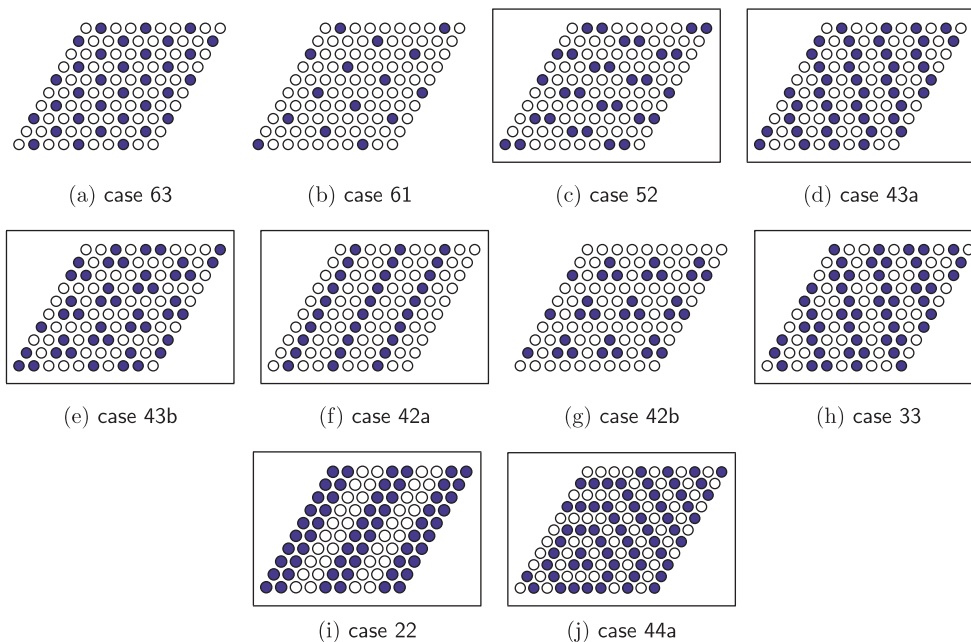

Figure 7. Illustrations of patterns of synchrony of finite classes in 10×10 periodic array.

Theorem 1.5. *Up to symmetry, there are 12 two-colour patterns of synchrony in square lattice differential equations with nearest and next nearest neighbour couplings: the seven patterns in figure 2 except for pattern (f), figure 3(a) and the four patterns in figure 6.*

Remark 1.6. All 12 patterns are doubly periodic. The patterns in figure 6 can be generated from figure 3(a) by interchanging black and white along diagonals on which black and white cells alternate.

Theorem 1.7. *There are 10 two-colour patterns of synchrony in hexagonal lattice differential equations with nearest neighbour coupling shown in figure 7. There are three infinite families of two-colour patterns of synchrony generated from the patterns in figure 8 by interchanging white and black on diagonals along which white and black cells alternate. Up to symmetry, these are all of the two-colour patterns of synchrony.*

Remark 1.8. Except for figure 7 case 44a, all other patterns in figure 7 are doubly periodic and the repeating patterns associated with these patterns are given in figure 9.

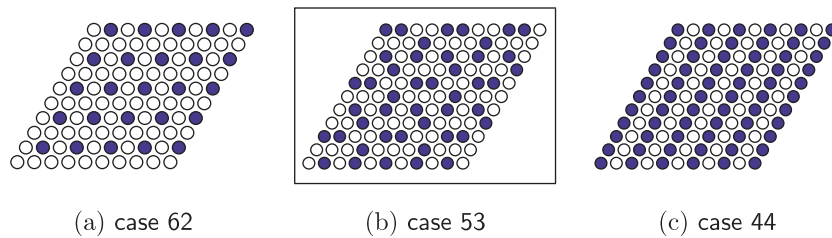

Figure 8. Illustrations of patterns of synchrony of infinite classes in 10×10 periodic array.

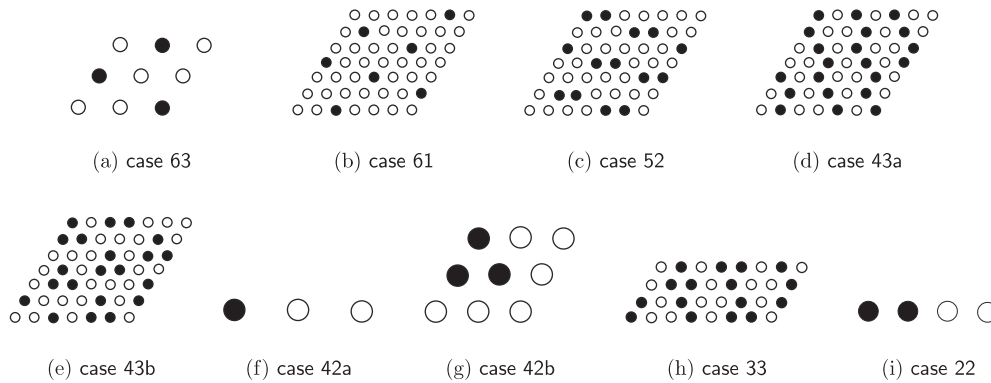

Figure 9. The repeating patterns associated with the figures in figure 7.

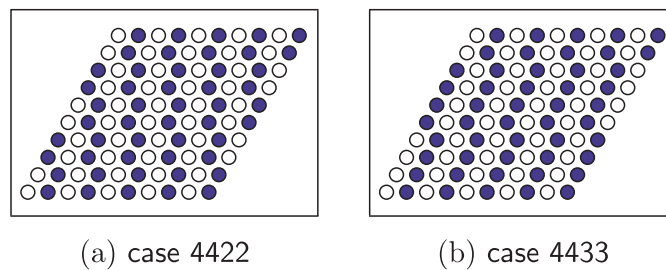

Figure 10. The two patterns in this figure and two patterns cases 62 and 44 in figure 8 are NN-balanced patterns in infinite classes. (a) case 4422 and (b) case 4433.

Theorem 1.9. *Up to symmetry, there are 13 two-colour patterns of synchrony in hexagonal lattice differential equations with nearest and next nearest neighbour couplings: the nine patterns in figure 7 except for pattern (j), figures 8(a) and (c), and the two patterns in figure 10.*

Remark 1.10. All 13 patterns are doubly periodic. The patterns in figure 10 can be generated from figure 8(c) by interchanging black and white along diagonals on which black and white cells alternate.

The structure of this paper is as follows. In section 2 we prove the bifurcation result for balanced two-colour equilibria. The remaining sections outline the proofs of theorems 1.3–1.9. Each proof contains a number of cases and we present only some of these here. All details may be found in [11] and [12]. Section 3 presents four of the ten cases in the proof of balanced two-colourings of square lattice dynamical systems with nearest neighbour

coupling. Section 4 proves the theorem for balanced two-colourings of square lattice dynamical systems with nearest and next nearest neighbour couplings. Section 5 presents two of the 21 cases in the proof of balanced two-colourings of hexagonal lattice dynamical systems with nearest neighbour coupling and section 6 presents one case in the proof of balanced two-colourings of hexagonal lattice dynamical systems with nearest and next nearest neighbour couplings.

The problem of determining all balanced k -colourings of square and hexagonal lattices when $k > 2$ seems daunting. The proof in $k = 2$ that we describe here does not seem to lead to general tractable methods. However, it is possible to prove that in square and hexagonal lattice dynamical systems with both nearest and next nearest neighbour couplings, all balanced k colourings are spatially doubly periodic (see [1]). For $k = 2$ this result appears as a corollary of the general classification theorem that we present here.

2. Bifurcation

As defined, patterns of synchrony correspond to flow-invariant subspaces Δ ; that is, if a lattice differential equation has a solution with initial conditions in Δ , then the solution will remain in Δ for all time. Our results do not state that specific kinds of solutions, such as equilibria, actually exist for specific equations or are stable. However, it is shown in [5, p 212] that for each balanced k -colouring with associated polydiagonal Δ , there exists an asymptotically stable equilibrium in Δ for some admissible system of differential equations.

Steady-state bifurcation theory provides a standard approach for finding certain types of equilibria. In this theory, it is usually assumed that a system of differential equations depends on one parameter λ and that the equation has a ‘trivial’ equilibrium. Steady-state bifurcations occur when some eigenvalues of the linearized equations at the trivial equilibrium change stability as λ is varied. Then bifurcation theory attempts to explain what kinds of equilibria can be obtained from the trivial one near a steady-state bifurcation. A *codimension one* bifurcation is one that occurs generically in systems when varying just one parameter. A prototypical success of this approach is the equivariant branching lemma [7, 8], which shows that in symmetric equations, spontaneous symmetry-breaking leads to equilibria with certain symmetry subgroups, namely, axial subgroups.

In this section, we state and prove an analogue to the equivariant branching lemma for homogeneous cell systems. We assume that the trivial equilibrium is *homogeneous*, that is, at equilibrium all cells have equal coordinates and are synchronous. We call a bifurcation from a synchronous equilibrium, a *synchrony-breaking* bifurcation. Our main result in this direction shows that equilibria corresponding to balanced two-colourings do occur by codimension one bifurcation from homogeneous equilibria.

Theorem 2.1. *For each balanced two-colouring of a homogeneous system, there exists a codimension one synchrony-breaking bifurcation from a homogeneous equilibrium that leads to a branch of equilibria corresponding to the given two-colouring.*

Proof. It is sufficient to prove this theorem for architectures with a single kind of coupling. Suppose a homogeneous coupled cell system has a balanced two-colour equivalence relation on the cells, then the system can be reduced to a two-cell quotient system [9] (the coupled cell system restricted to the synchrony subspace) with the network pictured in figure 11. Note that l_j is the number of times that cell j is coupled to itself, and m_j is the number of times that the other cell is coupled to cell j . Since the original system is homogeneous, so is the quotient.

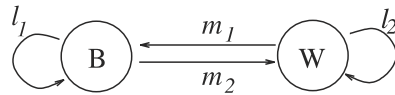

Figure 11. The network of the quotient system.

Hence

$$k \equiv l_1 + m_1 = l_2 + m_2, \tag{2.1}$$

where $l_1, l_2, m_1, m_2 \geq 0$.

The quotient system has the form

$$\begin{aligned} \dot{x}_1 &= f(x_1, \underbrace{\overline{x_1, \dots, x_1}}_{l_1 \text{ times}}, \underbrace{\overline{x_2, \dots, x_2}}_{m_1 \text{ times}}, \lambda), \\ \dot{x}_2 &= f(x_2, \underbrace{\overline{x_2, \dots, x_2}}_{l_2 \text{ times}}, \underbrace{\overline{x_1, \dots, x_1}}_{m_2 \text{ times}}, \lambda), \end{aligned} \tag{2.2}$$

where $x_i \in \mathbf{R}^n, \lambda \in \mathbf{R}$ is a parameter and f is invariant under all permutations of the variables under the bar. Since the original system is homogeneous, the space formed by setting all cells equal is a polysynchronous subspace. We assume that there is a trivial branch of synchronous equilibria which has the form $x_1 = x_2$ in the quotient network. Without loss of generality, we assume it is at $(0, 0, \lambda)$. It follows from (2.2) that the Jacobian matrix at $(0, 0, \lambda)$ has the form

$$J = \begin{pmatrix} A + l_1 B & m_1 B \\ m_2 B & A + l_2 B \end{pmatrix} \tag{2.3}$$

where $A = A(\lambda)$ is the matrix of linearized internal dynamics, and $B = B(\lambda)$ is the linearized coupling matrix.

We claim that the $2n$ eigenvalues of J (including multiplicity) are the eigenvalues of the $n \times n$ matrices $A + kB$ and $A + (l_1 + l_2 - k)B$. To verify this point, let μ be an eigenvalue of $A + kB$ (resp. $A + (l_1 + l_2 - k)B$) with eigenvector v . Then a straightforward calculation shows that $(v, v)^t$ (resp. $(m_1 v, -m_2 v)^t$) is an eigenvector of J with eigenvalue μ . In fact, the corresponding statement about eigenvalue multiplicity is valid.

Generically, $A + (l_1 + l_2 - k)B$ can have a simple real eigenvalue crossing zero with nonzero speed as λ varies, and with no other eigenvalue of $A + (l_1 + l_2 - k)B$ and $A + kB$ on the imaginary axis at the same value of λ . It then follows from Crandall and Rabinowitz [3] that there exists a unique smooth branch of nontrivial solutions to $f = 0$. Moreover, since the eigenvector $(m_1 v, -m_2 v)$ is not in a synchronous direction, the nontrivial solution satisfies $x_1 \neq x_2$. This means synchrony-breaking bifurcation occurs. ■

Theorem 2.1 is an analogue of the equivariant branching lemma [8] for balanced two-colourings. We note that the analogue of theorem 2.1 for balanced three-colourings is only sometimes valid. We present two examples: the first where the analogue is valid and the second where it is not.

1. The balanced three-colouring figure 12(a) has the quotient network figure 12(b). Note that figure 12(b) has \mathbf{Z}_2 -symmetry. \mathbf{Z}_2 -equivariant bifurcation theory shows that figure 12(a) can be expected from codimension one symmetry-breaking bifurcation from a homogeneous equilibrium.
2. The balanced three-colouring figure 13(a) has the \mathbf{D}_3 -symmetric quotient network figure 13(b). \mathbf{D}_3 -equivariant bifurcation theory shows that \mathbf{D}_3 symmetry-breaking leads to branches of equilibria with \mathbf{Z}_2 -symmetry. See [8, p 14] for details. So figure 13(a) cannot

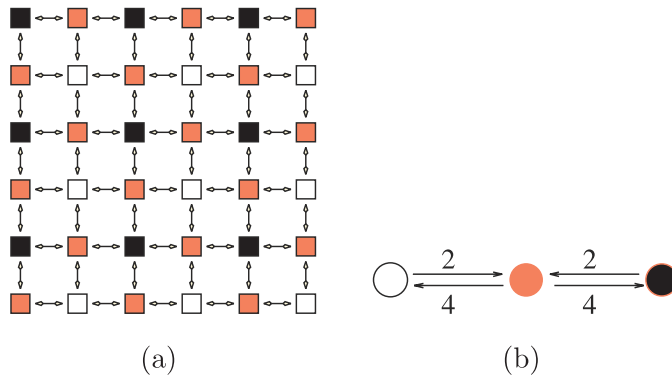

Figure 12. Pattern (a) can be obtained from synchrony-bifurcation.

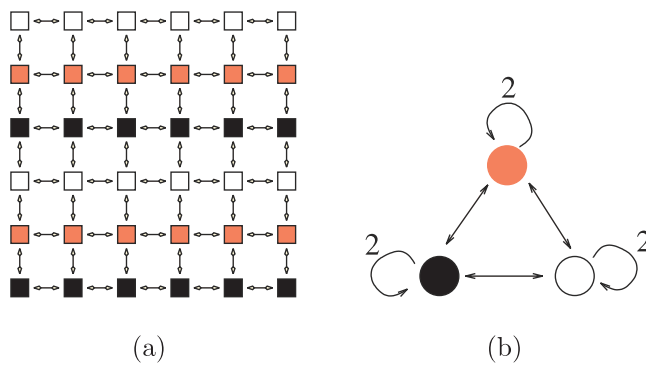

Figure 13. Pattern (a) cannot be obtained from synchrony-bifurcation.

be expected from codimension one symmetry-breaking bifurcation from a homogeneous equilibrium.

3. Square lattice with nearest neighbour coupling

In this section, we indicate how the proof of theorem 1.3 proceeds. Consider an infinite square lattice with bidirectional nearest neighbour coupling (horizontal and vertical only). Our object is to find all balanced two-colourings. Denote the two colours by black and white. We enumerate balanced two-colourings by their quotient networks. Denote each quotient by a pair of integers: the number of white cells coupled to black cells and the number of black cells coupled to white cells. We recall that *balanced colouring* means that each black cell receives the same number of inputs from black cells and from white cells. Similarly, each white cell receives the same number of inputs from black cells and from white cells. Since each cell in the array is either white or black and each has four inputs, the possible colouring of the input set of the cell can only be one of the five types listed in table 1.

Following our approach, case ij ($0 \leq i, j \leq 4$) represents the case that each black cell has i white and $4 - i$ black inputs, and each white cell has j black and $4 - j$ white inputs. Suppose that the input set of each black cell consists of four black cells, then the balanced planar pattern must consist of black cells. Similarly for white cells. So we do not need to consider these cases. In addition, note that case ij and case ji consist of the same patterns since swapping the

Table 1. Possible colouring of the input set of a cell.

| Black cells | White cells |
|-------------|-------------|
| 4 | 0 |
| 3 | 1 |
| 2 | 2 |
| 1 | 3 |
| 0 | 4 |

Table 2. Classification of balanced two-colourings. The last numbers are the numbers of patterns in corresponding cases.

| Cell of array | Black cell | | White cell | | Number of pattern(s) |
|---------------|------------|-------|------------|-------|----------------------|
| | White | Black | White | Black | |
| Case 44 | 4 | 0 | 0 | 4 | 1 |
| Case 43 | 4 | 0 | 1 | 3 | 0 |
| Case 42 | 4 | 0 | 2 | 2 | 1 |
| Case 41 | 4 | 0 | 3 | 1 | 1 |
| Case 33 | 3 | 1 | 1 | 3 | 1 |
| Case 32 | 3 | 1 | 2 | 2 | 1 |
| Case 31 | 3 | 1 | 3 | 1 | Infinity |
| Case 22 | 2 | 2 | 2 | 2 | Infinity |
| Case 12 | 1 | 3 | 2 | 2 | 2 |
| Case 11 | 1 | 3 | 3 | 1 | 1 |

colours of all cells of a pattern in case ij yields a pattern in case ji . So we need only to consider case ij ($1 \leq j \leq i \leq 4$). All cases that we need to consider are listed in table 2.

We define a *local pattern* to be a pattern enclosed by a polygon. We show that all patterns in finite classes are doubly periodic, and all patterns in each infinite class can be obtained from a doubly periodic pattern by interchange of colours along certain diagonals. In this paper, we present cases 41 and 32 (finite classes) by determining the local patterns that can be extended uniquely to the whole plane, then prove the results for cases 22 and 31 (infinite classes). Proof of the remaining cases can be found in [11, 12].

3.1. Finite classes

Case 41. Up to rotation, the local pattern around a white cell is pictured as figure 14(a). By assumption on the input set of the circled black cell, figure 14(a) determines figure 14(b) since black cells have four white inputs. Figure 14(b) determines figure 14(c) uniquely since white cells have only one black neighbour. Now consider the circled white cell in figure 14(c). It must have one black input and that cell will be in either position (1) or (2). Observe that positions (1) and (2) are symmetric about the line in figure 14(c). So, without loss of generality, we can put a black cell in position (2) and a white cell in position (1) arriving at figure 14(d). We claim that the local pattern enclosed by the dashed polygon in figure 14(d) determines the planar pattern obtained by repeating figure 14(a) periodically in two different directions.

By assumption on the input sets of the circled cells, we can see that figure 15(a) determines figure 15(d). That means that figure 15(a) determines the whole strip that is obtained by repeating figure 14(a) in the direction of line L .

In addition, by assumption on the input sets of circled cells in figure 16, we can see that figure 16(a) determines figure 16(d) uniquely. Thus, the strip can be extended in the direction

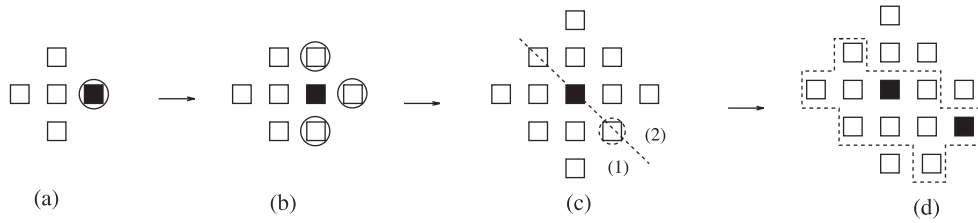

Figure 14. (Case 41) The possible local patterns.

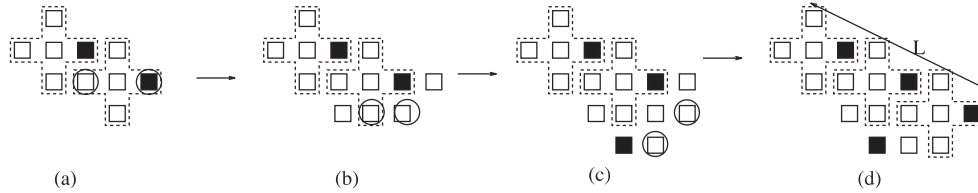

Figure 15. (Case 41) Pattern (a) determines a strip.

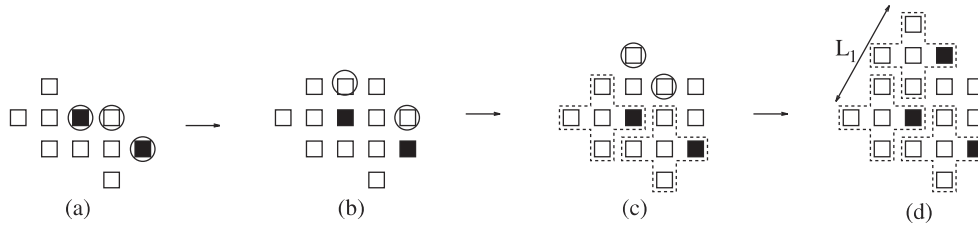

Figure 16. (Case 41) The strip determines the whole planar pattern.

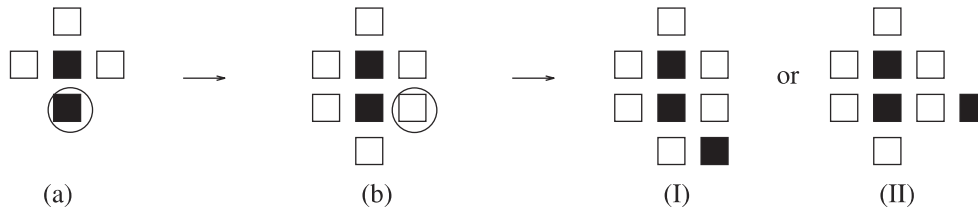

Figure 17. (Case 32) Possible local patterns.

of line L_1 in figure 16(d). So figure 15(a) determines the planar pattern pictured as figure 2 case 41.

Case 32. By rotation we may assume that the local pattern around a black cell is pictured as figure 17(a). By assumption on input set of the circled black cell, figure 17(a) determines figure 17(b). Now consider the circled white cell in figure 17(b). The white cell already has one black input, so the other black input cell must be one of the other two neighbours. The possible local patterns are figure 17 (I) and (II), which we will consider in order. We show that figure 17 (I) and (II) determine the same planar pattern up to symmetry.

- I. In figure 18, by assumption on the input sets of the circled cells, each pattern determines the next one uniquely. We claim that the local pattern, enclosed by the dashed polygon in figure 18(d), determines the planar pattern.

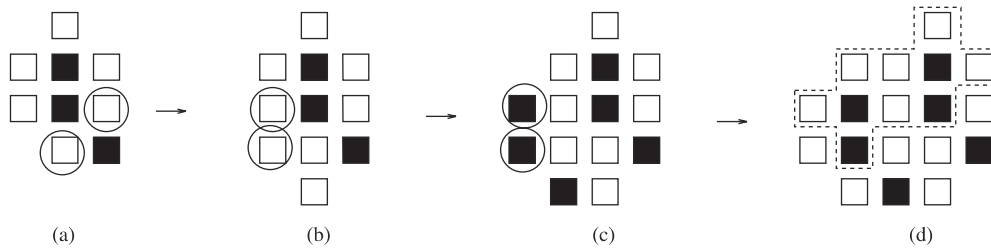

Figure 18. (Case 32) Local pattern around figure 17(I).

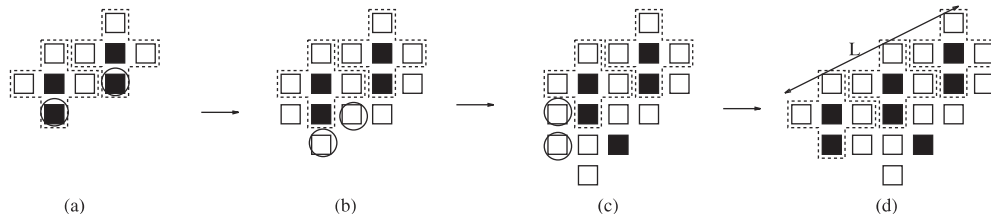

Figure 19. (Case 32) Pattern (a) determines a strip.

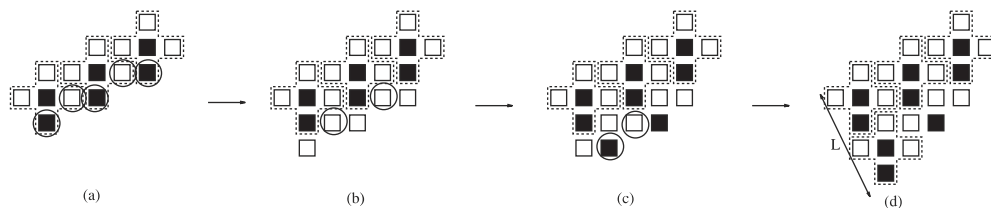

Figure 20. (Case 32) The strip can be extended to the whole plane.

Note that the region enclosed by dashes in figure 18(d) is just two copies of figure 17(a). This is not sufficient information to show that figure 17(a) can be repeated periodically in the direction L , since we arrived at figure 18(d) by using assumption (I). We now assert that the dashed region can be extended uniquely to three copies of figure 17(a) and hence to the whole strip. By assumption on input sets of circled cells, we see that figure 19(a) determines figure 19(d), which proves our assertion.

Now we need to see whether this strip can be extended to the whole plane uniquely. Observe that figure 20(a) determines figure 20(d) uniquely. Thus, the strip can be extended to the whole plane and we obtain figure 2 case 32.

- II. By assumption on input sets of circled cells, figure 21(a) determines figure 21(c). Observe that flipping figure 21(c) is figure 19(b). So the planar pattern in this case is the same pattern as the one found in I.

3.2. Infinite classes

By a *diagonal* we mean a slope ± 1 line of cells in the square lattice. We define an *alternating diagonal* to be a diagonal on which white cells and black cells alternate. Note that diagonals are either parallel or perpendicular. In cases 22 and 31, cells of both colours have the same input sets. The two cases share a property that is described in [5] and proved here.

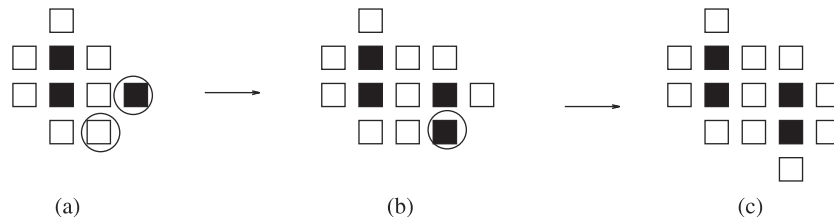

Figure 21. (Case 32) Pattern (a) determines the same pattern as the pattern obtained in (I).

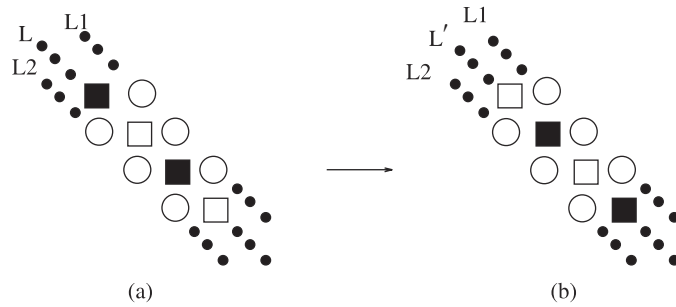

Figure 22. The common property of the two infinite cases.

Lemma 3.1. *Interchanging colour along an alternating diagonal of a balanced pattern gives a new balanced pattern.*

Proof. A cell c influences the balanced relation of a pattern in two ways. First, cell c has an input set. Second, c is in the input set of its nearest neighbours. Since black cells and white cells have the same input sets, we will not change the balanced relation in the first way if we interchange colour along an alternating diagonal. So we need only show that interchanging colour along an alternating diagonal also does not change the balanced relation of the pattern in the second way. In figure 22, we see that a cell in an alternating diagonal L only influences the cells in two diagonals L_1 and L_2 . The alternating diagonal L supplies one white and one black cell for every cell in L_1 or L_2 . When we interchange the colour of L and arrive at L' , L' is still alternating and supplies every cell in L_1 or L_2 with one white and one black input. Thus, interchanging colour of an alternating diagonal does not change the balanced relation. ■

Case 22. We prove that each pattern in case 22 can be transformed into figure 3(a), a pattern that consists of alternating black and white horizontal stripes, by interchanging black and white along a (perhaps infinite) set of alternating diagonals.

We first verify two properties concerning patterns in case 22.

1. If the diagonal L in figure 23 is alternating, then the parallel diagonal L_1 , two squares to the left of L , is also alternating.

Reason. Suppose L_1 is not alternating. Then two consecutive cells a and b in L_1 have the same colour. Without loss of generality, assume they are white. Next, consider cell c in figure 23, whose four neighbouring cells are a , b , and two cells in line L . Cell c has one black and three white inputs. This contradicts the assumption on input sets of cells. Thus, L_1 is an alternating diagonal. ■

Property 1 implies: if a diagonal is alternating, then every second parallel diagonal is also alternating.

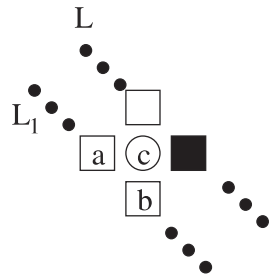

Figure 23. (Case 22) L_1 must be alternating.

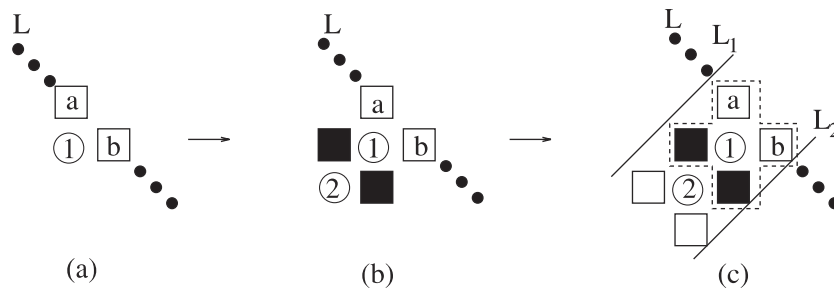

Figure 24. (Case 22) L is not alternating, then L_1 and L_2 must be alternating.

2. If a diagonal L in figure 24(a) is not alternating, then there is a pair of consecutive perpendicular alternating diagonals through a pair of consecutive cells on L .

Reason. Since L is not alternating, there are two consecutive cells a and b on L that have the same colour. Without loss of generality, assume the two cells are white (see figure 24(a)).

By assumption on the input sets of the cells in the numbered positions, we see that figure 24(a) determines figure 24(c). Hence, the pattern enclosed by the dashed polygon in figure 24(c), not including cell 1, is repeated periodically in the perpendicular direction L_1 to L . So the pair of perpendicular diagonals through a and b must be alternating. ■

Next, we use these properties to transform the pattern to figure 3(a) by interchanging black and white along some alternating diagonals.

By property 2, there must be an alternating diagonal. Without loss of generality, assume that the alternating diagonal is the diagonal L in figure 25. By property 1 and its remark, beginning from L , every other diagonal must be alternating. By lemma 3.1, we can interchange colour along some of the diagonals so that all of those alternating diagonals are as in figure 25.

Next, consider the diagonal L_1 marked by the line in figure 25. If L_1 is alternating, then every second diagonal beginning from L_1 is alternating. If L_1 is not alternating, then property 1 implies that there is a perpendicular alternating diagonal L_2 through a cell in L_1 . By property 1, beginning from L_2 , every other diagonal is alternating. Finally, proceed as in the first half of the argument to transform the pattern to the desired striped pattern.

Case 31. We prove that any pattern in case 31 can be transformed into figure 3(b) by interchanging black and white along a (perhaps infinite) set of alternating diagonals.

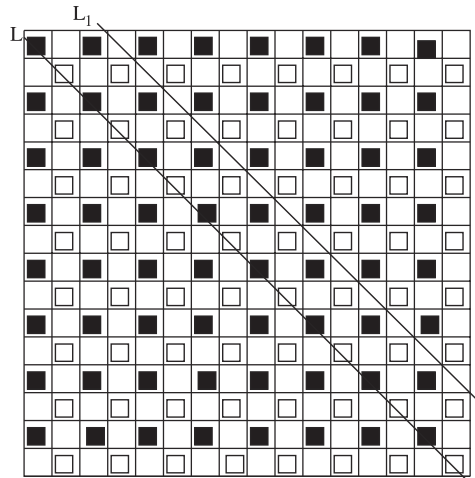

Figure 25. (Case 22) Generating process.

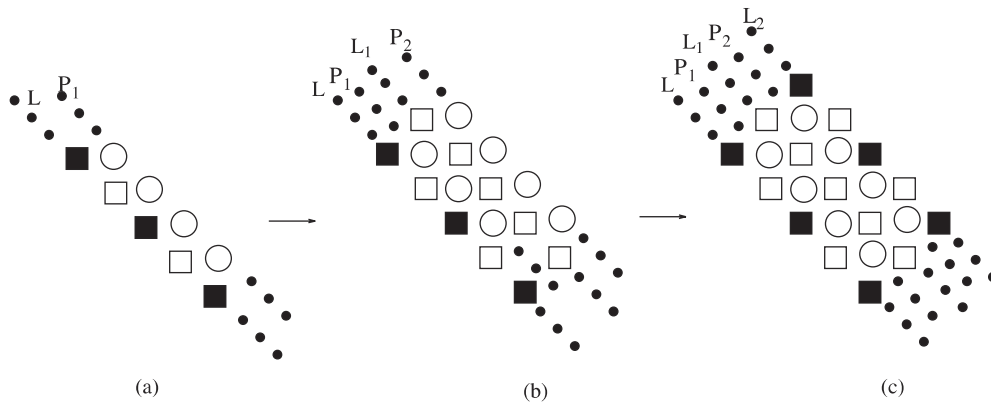

Figure 26. (Case 31) Alternating diagonals and white diagonals alternate every second diagonal.

We first verify two properties concerning patterns in case 31. For convenience, we call a diagonal that consists only of white cells a *white diagonal*.

1. Suppose the diagonal L in figure 26 is an alternating diagonal. Then, alternating diagonals and white diagonals alternate every second diagonal.

Reason. Since every cell in the diagonal P_1 in figure 26(a) has one white input and one black input from L , the other two inputs must be white. Therefore, the diagonal two squares to the right of L must be a white diagonal (see figure 26(b)). The assumption on the input sets of the cells on diagonal P_2 in figure 26(b) implies that the diagonal L_2 (two squares to the right of L_1) must be alternating. Thus, white diagonals and alternating diagonals alternate in the perpendicular direction to L . ■

Similarly, if L is a white diagonal, then the result is also true.

2. If the diagonal L is neither alternating nor white, then there exists a perpendicular alternating diagonal through a cell on L .

Reason. We may assume, after rotation, that L has slope -1 . Since L is neither alternating nor white, there exists a segment on L pictured in figure 27(a). (Note that the consecutive

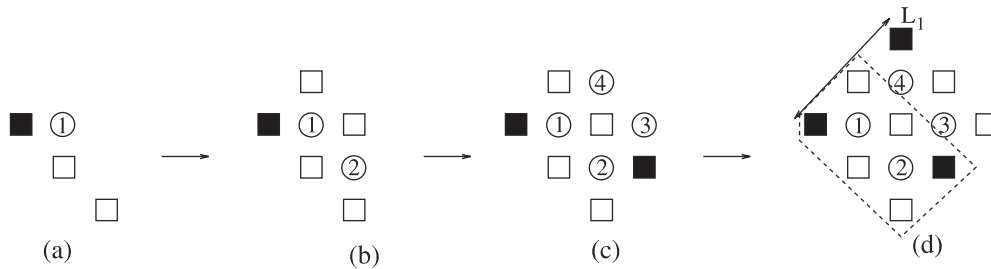

Figure 27. (Case 31) The existence of alternating diagonal.

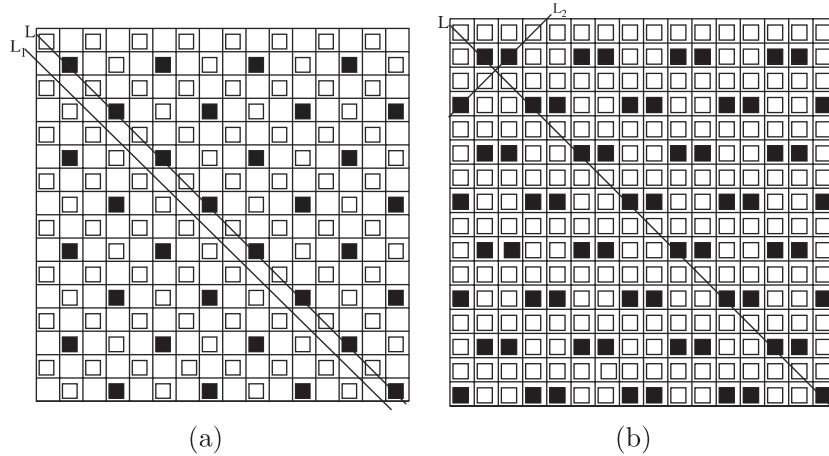

Figure 28. (Case 31) All patterns in case 31 can be transformed to the pattern (b).

same colour cells must be white.) Now consider the cell numbered 1. It has one white and one black input supplied by L , so the other two inputs must be white; and we arrive at figure 27(b).

Cell 2 in figure 27(b) already has three white inputs shown in figure 27(b), therefore the last input must be black. So figure 27(b) determines figure 27(c). Similarly, figure 27(c) determines figure 27(d) by assumption of the input sets of Cells 3 and 4. Observing figure 27(d), we can see that the local pattern in figure 27(d) enclosed by the dashed polygon, not including Cells 1 and 2, is repeated periodically along the line L_1 . So the diagonals through the black cells in figure 27(d) along the direction of L_1 must be alternating. ■

Next, we use these properties to transform the pattern to figure 3(b) by interchanging black and white along some alternating diagonals. By property 2, there must be an alternating diagonal. Without loss of generality, assume that the alternating diagonal is the diagonal L in figure 28. By property 1 and its remark, beginning from L , alternating diagonals and white diagonals alternate every other diagonal. By lemma 3.1, we can interchange colour along some of the diagonals so that those alternating diagonals are as in figure 28.

Next, consider the diagonal L_1 in figure 28(a). If L_1 is alternating or white, proceed as the first half of the argument to transform the pattern to the desired pattern. If L_1 is neither white nor alternating, by property 2, there is a perpendicular alternating diagonal L_2 through a cell in L_1 . Without loss of generality, assume L_2 as in figure 28(b). By lemma 3.1, we also can transform the original pattern to figure 3(b).

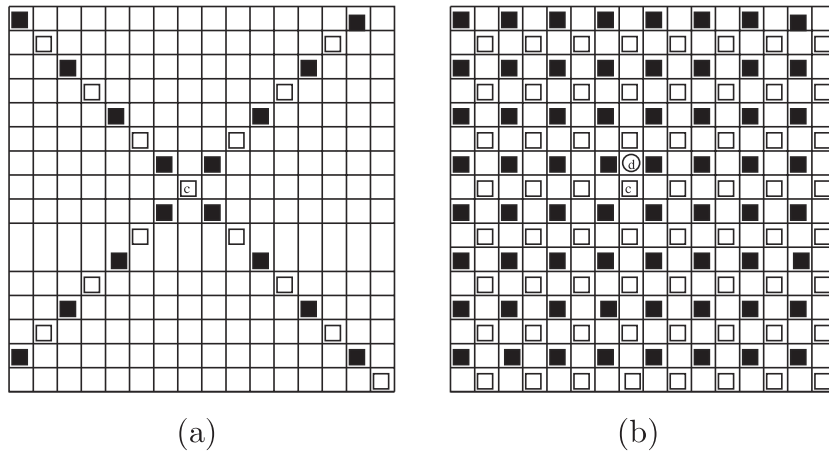

Figure 29. If both diagonals through c are alternating, there only one possible half pattern.

4. Square lattice with next nearest neighbour coupling

In this section, we prove theorem 1.5. The patterns of synchrony of square lattices with nearest and next nearest neighbour coupling are the patterns in theorem 1.3 which are also balanced with next nearest neighbour coupling. We say that a pattern in theorem 1.3 is *NN-balanced* if it is balanced with nearest and next nearest neighbour coupling. Thus, in order to prove theorem 1.5, we need only to check which patterns in theorem 1.3 are balanced with the additional coupling. It is easy to check that all patterns in figure 2, except for pattern (f), are NN-balanced. We use the phrase *NN-inputs of a cell* to mean the next nearest neighbours of the cell.

To prove theorem 1.5, we need to determine which balanced patterns associated with cases 22 and 33 are NN-balanced. We prove that precisely five patterns in case 22 are NN-balanced, and that none in case 31 are NN-balanced.

Case 22. Begin with the white cell c . We showed in section 3 that at least one diagonal through c is alternating. Therefore, we need to consider two cases: both diagonals are alternating; only one of the two diagonals is alternating.

- I. Suppose both diagonals through c are alternating as pictured in figure 29(a). By property 1 of section 3 case 22, the half pattern that contains c must be figure 29(b).

In figure 29(b), observe that each black cell has four white NN-inputs and each white cell has four black NN-inputs. So all NN-balanced patterns containing (b) must satisfy the same conditions on the NN-input sets. Therefore, if cell d in figure 29(b) is black, then the planar pattern is figure 3(a); if d is white, then the planar pattern is the pattern by rotating figure 3(a) by 90° .

- II. Suppose one diagonal L through c is not alternating. It follows that there are two adjacent cells c_1, c_2 in L that have the same colour. Without loss of generality, assume c_1, c_2 are white. By property 1 in section 3 case 22, the two perpendicular diagonals L_1, L_2 through c_1, c_2 , respectively must be alternating.

Next, we consider Cell c_3 which can be either white or black. Each of these two choices determines a half pattern uniquely as we show now.

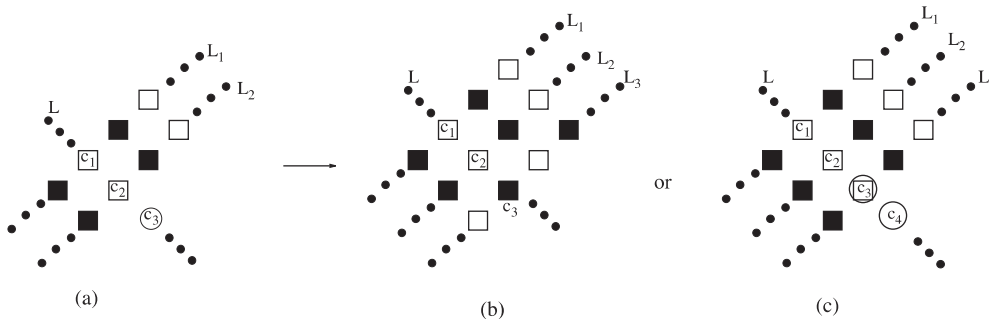

Figure 30. If one diagonal is not alternating, then there only two possible half patterns.

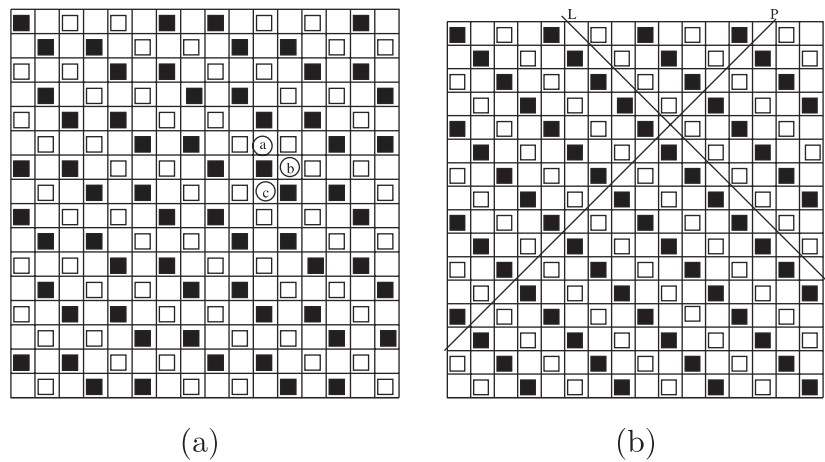

Figure 31. Figures 30(b) and (c) determine a half pattern uniquely, respectively.

1. If c_3 is black, by property 1 again, the alternating diagonal through c_3 must be pictured as L_3 in figure 30(b). From figure 30(b), we can see that all NN-balanced patterns containing figure 30(b) must satisfy that each black cell has one black and three white NN-inputs, and each white cell has one white and three black NN-inputs. With the same argument as section 3 case 33, the possible half pattern containing figure 30(b) can only be figure 31(a) up to symmetry. By assumption on the input sets, there must exist two adjacent black cells in the second half pattern. In figure 31(a), if cells a and b in figure 31(a) are black, then we get figure 6(a); if cells b and c are black, then we get figure 6(b). It is easy to check that up to symmetry, these two patterns are all the possible patterns with half patterns as pictured in figure 31(a).
2. If c_3 is white, then the alternating diagonal L_3 through c_3 must be as pictured in figure 30(c). It follows that each cell in all NN-balanced patterns must have two white and two black NN-inputs. Next, consider cell c_3 in figure 30(c). That cell already has two black NN-inputs, so cell c_4 must be white. It follows that L is a white diagonal. By property 1 in section 3 case 22 again, the NN-balanced half pattern containing (c) is formed by alternating white diagonals and black diagonals every second diagonal. See figure 31(b).

According to the arguments above in this section, we can see that the second half pattern must also be formed by alternating white diagonals and black diagonals every

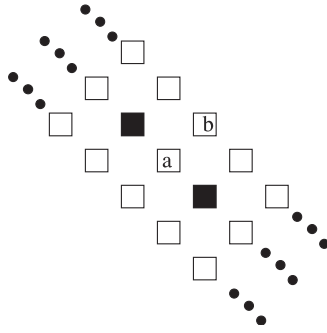

Figure 32. No pattern in the infinite family is NN-balanced.

Table 3. Possible colouring of the input set of a cell.

| Black cells | White cells |
|-------------|-------------|
| 6 | 0 |
| 5 | 1 |
| 4 | 2 |
| 3 | 3 |
| 2 | 4 |
| 1 | 5 |
| 0 | 6 |

second diagonal. Otherwise, the second half pattern cannot keep the same NN-input sets condition. In figure 31(b), if the diagonal P is black, then we get figure 6(c); if the diagonal L is black, then we get figure 6(d). It is easy to check that up to symmetry, these are the only two possible patterns containing figure 31(a).

Case 31. In this case, we claim that no pattern is NN-balanced. Recall that each pattern in the infinite family consists of two half patterns. Each half pattern is formed by repeating a pair of diagonals: one white and one alternating. So all patterns in this case include the pattern in figure 32. Note that the white cell a has two white and two black NN-inputs, while the white cell b has at least three white NN-inputs. This implies no NN-balanced pattern exists in the infinite family.

5. Hexagonal lattice with nearest neighbour coupling

In this section, we sketch the proof of theorem 1.7 proceeding as in section 3. As before, we enumerate balanced two-colourings by a pair of integers: the number of white cells coupled to black cells and the number of black cells coupled to white cells. For hexagonal lattices, the possible colouring of input sets of cells are listed in table 3.

Following our approach, case ij ($0 \leq i, j \leq 6$) represents the case that each black cell has i white and $6 - i$ black inputs, and each white cell has j black and $6 - j$ white inputs. Note that case ij and case ji consist of the same patterns since swapping the colours of all cells in a pattern of case ij obtains a pattern in case ji . In addition, the only possible pattern of case $i0$ ($0 \leq i \leq 6$) is the pattern consisting of white cells since all input cells of white cells are white. Thus, we need only to consider the case ij ($0 < j \leq i \leq 6$) that are listed in table 4.

Table 4. Classification of balanced two-colourings. The last numbers are the numbers of patterns in corresponding cases.

| Cell of array | Black cell | | White cell | | Number of patterns |
|---------------|------------|-------|------------|-------|--------------------|
| | White | Black | White | Black | |
| Case 66 | 6 | 0 | 0 | 6 | 0 |
| Case 65 | 6 | 0 | 1 | 5 | 0 |
| Case 64 | 6 | 0 | 2 | 4 | 0 |
| Case 63 | 6 | 0 | 3 | 3 | 1 |
| Case 62 | 6 | 0 | 4 | 2 | Infinity |
| Case 61 | 6 | 0 | 5 | 1 | 1 |
| Case 55 | 5 | 1 | 1 | 5 | 0 |
| Case 54 | 5 | 1 | 2 | 4 | 0 |
| Case 53 | 5 | 1 | 3 | 3 | Infinity |
| Case 52 | 5 | 1 | 4 | 6 | 1 |
| Case 51 | 5 | 1 | 5 | 1 | 0 |
| Case 44 | 4 | 2 | 2 | 4 | Infinity |
| Case 43 | 4 | 2 | 3 | 3 | 2 |
| Case 42 | 4 | 2 | 4 | 2 | 2 |
| Case 41 | 4 | 2 | 5 | 1 | 0 |
| Case 33 | 3 | 3 | 3 | 3 | 1 |
| Case 32 | 3 | 3 | 4 | 2 | 0 |
| Case 31 | 3 | 3 | 5 | 1 | 0 |
| Case 22 | 4 | 2 | 4 | 2 | 1 |
| Case 21 | 2 | 4 | 5 | 1 | 0 |
| Case 11 | 1 | 3 | 3 | 1 | 0 |

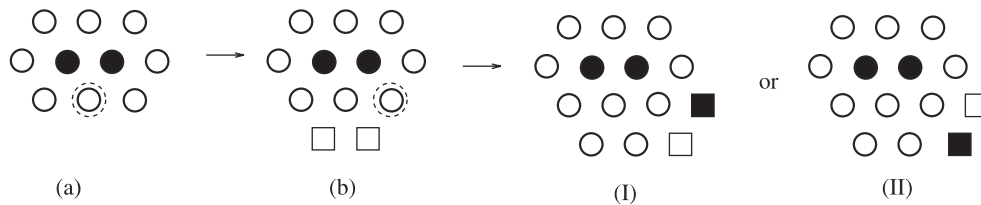

Figure 33. (Case 52) Possible local patterns.

In a hexagonal lattice, we call a line of cells of slope 0 or $\pm \frac{\sqrt{3}}{2}$ a *diagonal*. We show that all planar patterns except one in finite classes are doubly periodic, and all patterns in each infinite class can be obtained from a doubly periodic pattern by interchange of colours along certain diagonals. In this paper, we present case 52 (finite class) by determining the local pattern that can be extended uniquely to the planar pattern, then prove the result for case 62 (infinite class). Proof of the remaining cases may be found in [11, 12]. In this section, we use circles to represent the known cells and squares to represent the cells just added.

Case 52. Up to symmetry, patterns in this case contain figure 33(a). By assumption on the input set of the circled cell, figure 33(a) determines figure 33(b). Now consider the circled white cell in figure 33(b). That cell already has one black and three white inputs. By assumption on the input set, the other two neighbouring cells of the white cell are white and black. The possible local patterns are shown in figure 33 (I) and (II). We show that, up to symmetry, the two local patterns determine the same planar pattern.

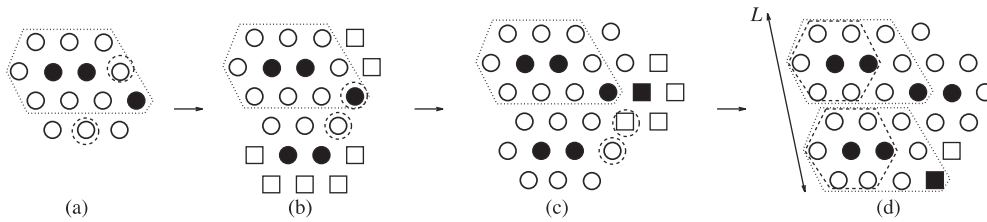

Figure 34. (Case 52) The pattern in the dashed polygon is repeated in the direction L .

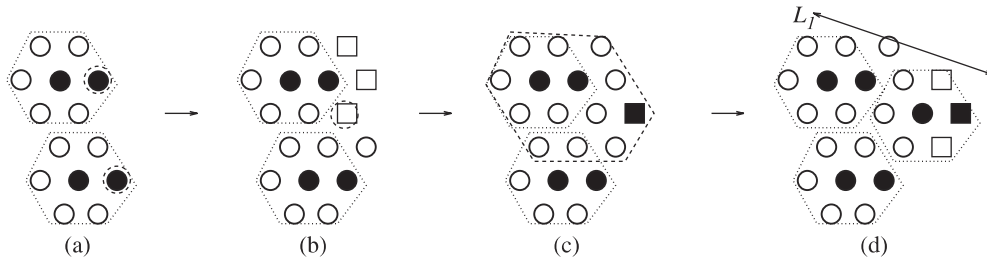

Figure 35. (Case 52) The strip determines a planar pattern.

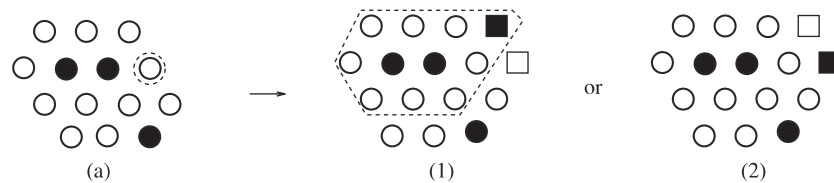

Figure 36. (Case 52) Pattern (1) determines a planar pattern, and pattern (2) is impossible.

I. Begin with figure 34(a) (figure 33 (I)). By assumption on the input sets of the circled cells, figure 34(a) determines figure 34(d). Note that the local pattern enclosed by the dotted polygon in figure 34(a) determines figure 34(a). So, we can see that the local patterns enclosed by the dashed polygons in figure 34(d) are repeated periodically in the direction L , forming a strip.

Next, we prove that the strip determines the planar pattern. By assumption on the input sets of circled cells, figure 35(a) determines figure 35(c). Note that the local pattern enclosed by the dashed polygon in figure 35(c) is the same pattern as figure 34(a). By the argument in the last paragraph, we know that figure 35(c) determines figure 35(d). Thus, the strip can be expanded to a planar pattern, arriving at figure 7 case 52. ■

II. Begin with figure 36(a) (figure 33 (II)). Consider the circled white cell in figure 36(a). The cell already has three white and one black inputs, so the other two neighbouring cells are white and black. The possible local patterns are shown in figure 36 (1) and (2). Note that the local pattern enclosed by the dashed polygon in figure 36 (1) is the same pattern as the local pattern enclosed by the dotted polygon in figure 34(a) up to symmetry. Thus, figure 36 (1) also determines figure 7 case 52. So we need only consider figure 36 (2). We show that figure 36 (2) is impossible.

In figures 37 and 38, we consider figure 36 (2). By assumption on the input sets of the circled cells and the cells in the dashed polygon, figure 37(a) determines figure 38(d).

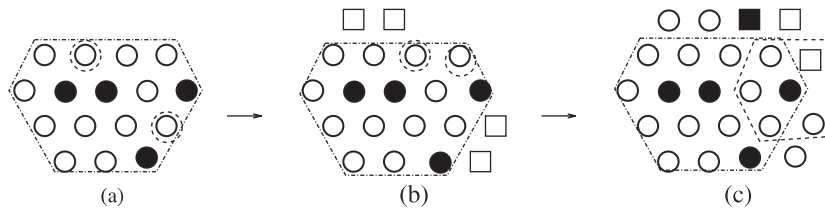

Figure 37. (Case 52) Pattern (a) determines pattern (f).

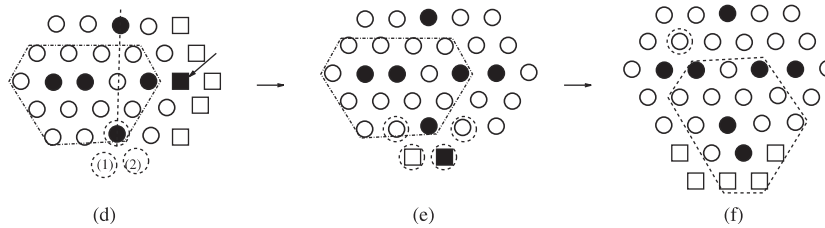

Figure 38. (Case 52) The circled white cell in pattern (f) is a contradiction.

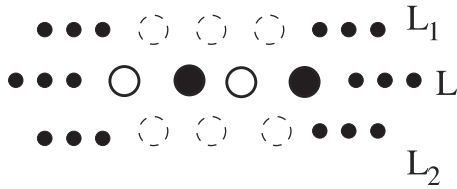

Figure 39. The common property of infinite classes.

By considering the input set of the circled black cell in figure 38(d), cells 1 and 2 must be one white and one black. Note that figure 38(d) is symmetric about the dashed line. So, without loss of generality, we assume cell 1 is white, and cell 2 is black arriving at figure 38(e). It is easy to see that figure 38(e) determines figure 38(f). Observe that the local pattern enclosed by dashes in figure 38(f) is the same pattern as figure 37(a). Since figure 37(a) determines figure 38(d), figure 37(a) determines the cell marked by the arrow in figure 37(d) to be black. Thus, figure 38(f) forces the circled cell in figure 38(f) to be black, which is a contradiction. ■

Case 62. We prove that each pattern in this case can be transformed to figure 8(a). Before we begin to prove the result of this case, we prove a result that is valid for all infinite classes.

Lemma 5.1. *If the number of black inputs of each white cell is equal to the number of black inputs of each black cell plus two, then interchanging colour along an alternating diagonal of a balanced pattern gives a new balanced pattern.*

Proof. Suppose each white cell has m ($2 \leq m \leq 4$) black and $6 - m$ white inputs, and each black cell has $m - 2$ black and $6 - (m - 2)$ white inputs. Let the diagonal L in figure 39 be alternating. Since balanced relations are determined by constraints on input sets, each cell c on L influences a balanced relation of a pattern in two ways. First, cell c has an input set. Second, cell c is in the input sets of its nearest neighbours. So the cells on L influence the balanced

Table 5. The distribution of inputs of cells on L .

| Cells on L | Distribution of inputs | | | |
|--------------|------------------------|---------|-----------------|---------------|
| | L | | L_1 and L_2 | |
| White cell | 2 black | 0 white | $m - 2$ black | $6 - m$ white |
| Black cell | 0 black | 2 white | $m - 2$ black | $6 - m$ white |

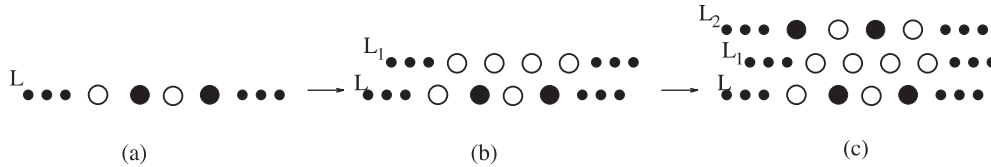

Figure 40. (Case 62) White diagonals and alternating diagonals alternate.

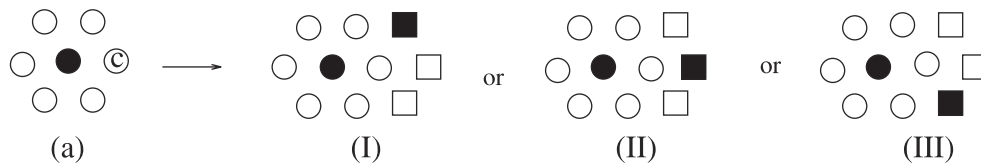

Figure 41. (Case 62) Possible local patterns of case 62.

relation for the cells on L , and the cells on the two neighbouring diagonals L_1 and L_2 . Table 5 shows the distribution of inputs of the cells on L . From table 5, we can see that L_1 and L_2 supply the same number of white inputs and the same number of black inputs for each cell on L . So the balanced relation for the cells on L is not changed when we interchange colour along L . Note that L supplies one white and one black input to each cell on L_1 and L_2 . So the balanced relation for the cells on L_1 and L_2 is also not changed when we interchange colour along L . Thus, the balanced relation of a balanced pattern is not changed when interchanging colour along an alternating diagonal. ■

Next we verify a property concerning patterns in this case.

Proposition 5.2. *Let L be an alternating diagonal. Then parallel diagonals alternate between all white and alternating.*

Reason. By assumption on the input sets of the cells in L in figure 40(a), the neighbouring diagonal L_1 in figure 40(b) must be a white diagonal. By assumption on the input sets of the white cells on L_1 , diagonal L_2 must contribute one white and one black input to each cell on L_1 . Hence L_2 must be alternating. Thus, parallel diagonals alternate between all white and alternating. ■

Next we prove that *there always exists an alternating diagonal* by determining the local pattern that can be extended to a strip containing an alternating diagonal. Begin with the local pattern figure 41(a). Consider the input set of cell c . That cell has a black input in figure 41(a), so the other three neighbouring cells must be two white and one black. The possible local patterns are figure 41 (I), (II) and (III). Observe that flipping pattern (I) about the horizontal midline is pattern (III). Therefore, we need only consider patterns (I) and (II).

- I. Here we consider figure 41 (I). By assumption on the input set of the circled cell, figure 42(a) determines figure 42(b). Next considering the input set of the circled white

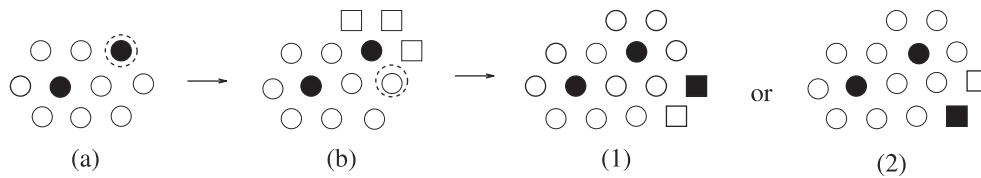

Figure 42. (Case 62) Possible local patterns around figure 41 (I).

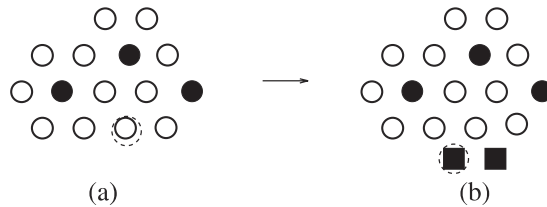

Figure 43. (Case 62) Impossible local patterns around Figure 42(a).

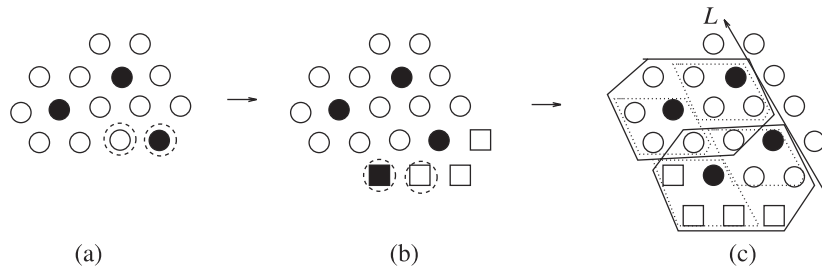

Figure 44. (Case 62) (a) determines a strip containing two alternating diagonals.

cell in figure 42(b), the possible local patterns are figure 42 (1) and (2). We assert that pattern (1) is impossible, and pattern (2) determines a strip.

1. We consider figure 42 (1). By assumption on the input set of the circled cell, figure 43(a) determines figure 43(b). Observe that the circled black cell in figure 43(b) has a black input. This contradicts the assumption that the black cell has no black input. Thus, figure 42 (1) cannot appear in the patterns of this case. This means that figure 42(a) determines figure 42 (2).
 2. Next we prove that figure 42 (2) determines a strip. By assumption on the input sets of the circled cells, figure 44(a) determines figure 44(c). Note that the local patterns enclosed by the solid polygons in figure 44(c) are the same patterns as figure 42(a). Since figure 42(a) determines figure 42 (2) or figure 44(a), we can see that the local patterns enclosed by the dotted polygons in figure 44(c) are repeated in the direction L . Then we can see that figure 44(a) determines the strip obtained by expanding figure 44(a) in the direction L . Obviously, the strip contains two alternating diagonals.
- II. Here we consider figure 41 (II). We assert that if the horizontal diagonal through the black cells in figure 41 (II) is not alternating, then the patterns containing figure 41 (II) must contain local pattern figure 41 (I) or (III). Suppose the diagonal is not alternating, then it must contain up to symmetry a segment pictured in figure 45(a). By assumption on the input sets of the circled cells, figure 45(a) determines figure 45(b). The possible local patterns enclosed by the dashed polygon can only be figure 41 (I) or (III). ■

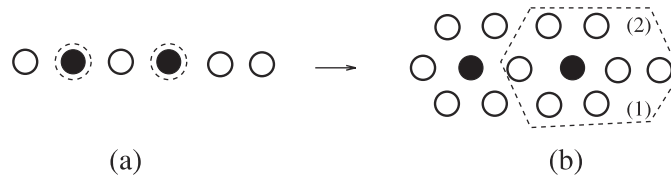

Figure 45. (Case 62) If L is not alternating, then the patterns must contain figure 41 (I) or (III).

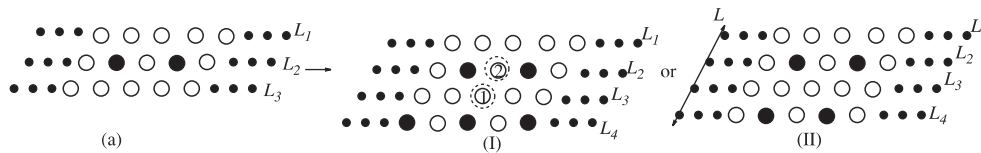

Figure 46. (Case 62) NN-balanced pattern.

Following the above arguments, there must be an alternating diagonal. By property 5.2, each pattern in this case consists of parallel diagonals which alternate between all white and alternating. That is, each pattern in this case can be transformed to figure 8 case 62. ■

6. Hexagonal lattice with next nearest neighbour coupling

In this section, we describe the structure of the proof of theorem 1.9. The patterns of synchrony of hexagonal lattices with nearest and next nearest neighbour coupling are the patterns in theorem 1.7 which are also NN-balanced. Thus, in order to prove theorem 1.9, we need only check which patterns in theorem 1.7 are NN-balanced. It is easy to check that all patterns in figure 7, except for pattern (j), are NN-balanced.

Next we need to determine which balanced patterns associated with the infinite classes are NN-balanced. We find there are only four patterns in infinite classes that are NN-balanced. We show here that only one pattern in case 62 is NN-balanced.

Case 62. By property 5.2 of case 62 in section 5, each pattern consists of parallel diagonals that alternate between alternating and all white. So, up to symmetry, each pattern in this case contains the strip in figure 46(a) that consists of two white diagonals L_1 and L_3 and an alternating diagonal L_2 . Since L_4 is alternating, there are two possible patterns shown in figure 46 (I) and (II). In figure 46 (I), note that the white cell 1 has at most four white NN-inputs, and the white cell 2 has at least five white NN-inputs. So figure 46 (I) is impossible in an NN-balanced pattern. It is easy to check that figure 46 (II) is possible in an NN-balanced pattern. Thus, figure 46(a) is repeated in direction L obtaining figure 8(a). ■

Acknowledgments

This work was supported in part by NSF Grant DMS-0244529 and ARP Grant 003652-0032-2001.

References

[1] Antoneli F, Dias A P S, Golubitsky M and Wang Y 2004 Patterns of synchrony in lattice dynamical systems *Preprint* Department of Mathematics, University of Houston

- [2] Chow S-N, Mallet-Paret J and Van Vleck E S 1996 Pattern formation and spatial chaos in spatially discrete evolution equations *Comput. Dynam.* **4** 109–78
- [3] Crandall M and Rabinowitz P 1971 Bifurcation from simple eigenvalues *J. Funct. Anal.* **8** 321–40
- [4] Gillis D and Golubitsky M 1997 Patterns in square arrays of coupled cells *J. Math. Anal. Appl.* **208** 487–509
- [5] Golubitsky M, Nicol M and Stewart I 2004 Some curious phenomena in coupled cell systems *J. Nonlinear Sci.* **14** 119–236
- [6] Golubitsky M and Stewart I 2002 Patterns of oscillation in coupled cell systems *Geometry, Dynamics, and Mechanics: 60th Birthday Volume for J E Marsden* ed P Holmes *et al* (Berlin: Springer) pp 243–86
- [7] Golubitsky M and Stewart I 2002 *The Symmetry Perspective (Progress in Mathematics vol 200)* (Basel: Birkhäuser)
- [8] Golubitsky M, Stewart I and Schaeffer D G 1988 *Singularities and Groups in Bifurcation Theory II (Applied Mathematics Sciences vol 69)* (New York: Springer)
- [9] Golubitsky M, Stewart I and Török A 2004 Patterns of synchrony in coupled cell networks with multiple arrows *SIAM J. Appl. Dynam. Syst.* **3** no 4
- [10] Stewart I, Golubitsky M and Pivato M 2003 Symmetry groupoids and patterns of synchrony in coupled cell networks *SIAM J. Appl. Dynam. Syst.* **2** 609–46
- [11] Wang Y 2006 Patterns of synchrony *PhD Thesis* Department of Mathematics, University of Houston, in preparation
- [12] Wang Y and Golubitsky M 2004 Two-color patterns of synchrony in lattice dynamical systems *Report* University of Houston, <http://www.math.uh.edu/~mg/reprints/>