

A Theory for Imperfect Bifurcation via Singularity Theory*

M. GOLUBITSKY AND D. SCHAEFFER
Queens College *Duke University*

1. Introduction

a. A synopsis. In this paper we use the theory of singularities to study bifurcation diagrams when subjected to small perturbations or imperfections. Our goal is to classify for a given problem all possible perturbed diagrams in some suitable qualitative way. We have achieved this goal in several important special cases including some bifurcations from a double eigenvalue and some bifurcations from a simple eigenvalue not satisfying the non-degeneracy condition of Crandall and Rabinowitz [7].

We are concerned with a non-linear equation

$$(1.1) \quad G(x, \lambda) = 0 \quad \text{and} \quad G(0, 0) = 0,$$

where $G(\cdot, \lambda) : \chi_1 \rightarrow \chi_2$ is a one-parameter family of smooth maps between two Banach spaces. Let $G_0(x) = G(x, 0)$. The inverse function theorem states that no bifurcation is possible near the solution $(x, \lambda) = (0, 0)$ of (1.1) when the differential dG_0 is invertible since for each λ there is only one solution $x(\lambda)$, which depends smoothly on λ . We consider only the case when dG_0 is singular, although we assume that dG_0 is Fredholm. Because of this hypothesis, the Lyapunov-Schmidt reduction (cf. [20]) allows us to reduce (1.1) to a finite system of equations resulting from the reduced mapping $\bar{G} : \ker dG_0 \times \mathbf{R} \rightarrow \chi_2 / \text{range } dG_0$. Indeed we suppose that this reduction *has already been performed* so that (1.1) is really only a finite system of equations. (See Section 6 for an explicit example of this reduction. The Lyapunov-Schmidt procedure extends to perturbations, as is also shown in Section 6 for this example. Thus the effect of an arbitrary small perturbation of the original problem is described completely by the resulting perturbation of the reduced equation. We lose no generality in restricting our attention to the reduced equation.) We assume that $G : \mathbf{R}^n \times \mathbf{R} \rightarrow \mathbf{R}^m$ is C^∞ and maps the origin in $\mathbf{R}^n \times \mathbf{R}$ into the origin in the range. All of our statements concern the behavior of G in a small neighborhood of the origin—in other words, G is a

* The research of the first author was partially supported by the National Science Foundation under Grant No. MCS-77-03655, and by a grant from the Sloan Foundation at the Courant Institute and by the Research Foundation of CUNY. The research of the second author was sponsored in part by the National Science Foundation under Grant No. MCS77-04148 and the U.S. Research Center, Madison, Wisconsin. Reproduction in whole or in part is permitted for any purpose of the United States Government.

germ of a mapping. We shall call

$$D(G) = \{(x, \lambda) \in \mathbf{R}^n \times \mathbf{R} : G(x, \lambda) = 0\}$$

the *bifurcation diagram* associated to (1.1).

One should note that the reduction from G to \bar{G} described above can be carried out in many possible ways since there is no canonical choice of coordinates for either $\ker dG_0$ or $\chi_2/\text{range } dG_0$. Thus we regard as equivalent two bifurcation problems which differ only by changes of coordinates. More specifically, we shall call two mappings $G, H : \mathbf{R}^n \times \mathbf{R} \rightarrow \mathbf{R}^m$ *contact equivalent* if there exists a (smoothly) parametrized family of invertible matrices $\tau_{x,\lambda}$ on \mathbf{R}^m and a diffeomorphism on $\mathbf{R}^n \times \mathbf{R}$ of the form $(x, \lambda) \rightarrow (\rho(x, \lambda), \Lambda(\lambda))$ such that

$$(1.2) \quad H(x, \lambda) = \tau_{x,\lambda} \cdot G(\rho(x, \lambda), \Lambda(\lambda)).$$

Here we assume that $\rho(\cdot, \lambda)$ and Λ are orientation preserving and that $(\rho(0, 0), \Lambda(0)) = 0$. Although we write $\mathbf{R}^n \times \mathbf{R}$ for the domain of $\tau_{x,\lambda}$ and of (ρ, Λ) , it is to be understood that these functions need be defined only for (x, λ) in some small neighborhood of the origin. The neighborhood of course depends on the functions G and H for which the contact equivalence is to be established. In other words, contact equivalence is a germ concept.

It is clear that multiplication by the matrix $\tau_{x,\lambda}$ has no effect on possible solutions of (1.1). (The reader may wonder why we do not allow non-linear changes of coordinates in the range in (1.2); Lemma 1.3 below shows that no generality would be gained by such a complication.) The diffeomorphism (ρ, Λ) can move the solution set of (1.1), but it will not change its qualitative nature. Notice however that we do not mix x and λ in the λ -coordinate of the diffeomorphism. This restriction is motivated by the applications in which x characterizes the state of some physical system, while λ is an external parameter. If the experimenter chooses a value of λ , the system settles into an equilibrium state satisfying (1.1) with λ equal to that chosen value. For this reason we insist that slices of constant λ be preserved in (1.2). This restriction is one of the basic ways in which our approach differs from previous attempts to describe bifurcations through singularity theory.

There are two principal questions raised in our analysis of perturbed bifurcation. The first is to describe in finite terms (up to contact equivalence) an arbitrary perturbation of a given bifurcation problem. Briefly our approach to this question is as follows. Given the bifurcation problem $G(x, \lambda)$, consider the set \mathcal{O} of all mappings contact equivalent to G . In general, \mathcal{O} will not contain all the C^∞ maps in any neighborhood of G . In many important cases, however, the complement of \mathcal{O} in a small neighborhood of G may be described by a finite number of parameters. When this is true an arbitrary

imperfection can be represented in terms of these parameters, at least up to contact equivalence. Singularity theory provides algebraic machinery to determine the number of parameters needed and how these parameters should be *inserted into the equations*. In more technical language, we are led to the so-called universal unfolding $F(x, \lambda, \alpha)$ of $G(x, \lambda)$, an l -parameter family of distinguished perturbations of $G(x, \lambda)$. Here $\alpha \in \mathbf{R}^l$ and $F(x, \lambda, 0) = G(x, \lambda)$. An arbitrary small perturbation of G is equivalent to $F(\cdot, \cdot, \alpha)$ for some $\alpha \in \mathbf{R}^l$. More precise definitions and results are given in Section 2.

The second principal question in this paper is to enumerate all the possible, inequivalent bifurcation diagrams that may arise from perturbation of the given problem $G(x, \lambda)$. In view of the construction above, it suffices to consider the bifurcation diagrams

$$\{(x, \lambda) \mid F(x, \lambda, \alpha) = 0\}$$

when α ranges over a small neighborhood of the origin in \mathbf{R}^l . We show that if a perturbed problem $F(\cdot, \cdot, \alpha)$ is *not* stable, then α must lie on one of three algebraic surfaces in \mathbf{R}^l , described below. These surfaces divide the ball $\{\alpha \in \mathbf{R}^l : |\alpha| < \varepsilon\}$ into finitely many regions, and any two problems associated to two values of α lying in the same region are equivalent. Thus enumeration of the open regions provides an enumeration of the possible stable perturbed diagrams. (Further analysis is required for the unstable problems associated to boundary points of the regions.) The separating hypersurfaces are only given implicitly, and in general this enumeration is quite difficult. Of course such an algorithm is amenable to computer analysis; moreover, in Sections 4 and 5 we implement the algorithm explicitly for several of the more elementary examples.

The following lemma, due to Mather [16], shows that no generality would be gained by allowing non-linear changes of coordinates on the range in (1.2).

LEMMA 1.3. *Let $T_{x,\lambda}$ be a parametrized family of diffeomorphisms on \mathbf{R}^m such that $T_{x,\lambda}(0) = 0$ for all x, λ . Let $H(x, \lambda) = T_{x,\lambda}(G(x, \lambda))$; then G and H are contact equivalent.*

b. A simple example. In this section we illustrate the kind of information our theory can provide about a bifurcation problem by discussing a simple example. Specifically we consider the finite element analogue of the Euler beam problem illustrated in Figure 1.1. (In Section 6 we consider the continuous problem.) This system, consisting of two rigid rods of unit length connected by frictionless pins, is subjected to a compressive force λ which is resisted by a torsional spring of unit strength. In terms of the angle x in the

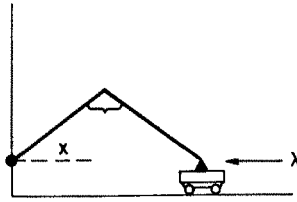

Figure 1.1. Illustration of the finite element analogue of the Euler beam problem.

figure, the potential energy of this system is

$$V = \frac{1}{2}x^2 + 2\lambda \cos x,$$

and the condition for equilibrium is

$$\frac{\partial V}{\partial x} = x - 2\lambda \sin x = 0.$$

A simple calculation shows that when $\lambda = \frac{1}{2}$ this system undergoes a supercritical bifurcation, this term being defined as follows. A bifurcation at $\lambda = \lambda_0$ of the equation $G(x, \lambda) = 0$ from a trivial solution $x(\lambda)$ is called *supercritical* (respectively *subcritical*) if there is only one solution of the equation in some neighborhood of $x(\lambda_0)$ for $\lambda < \lambda_0$ (respectively $\lambda > \lambda_0$). It is called *transcritical* otherwise.

The bifurcation diagram of this problem is the familiar pitchfork, illustrated in Figure 1.2(a). It is well known (cf. [25], [17]) that a small perturbation of this problem, either in the form of a central load or an initial curvature of the strut, will split the bifurcation diagram into two disconnected smooth components, as suggested in Figure 1.2(b). (In the figure dotted lines indicate an unstable solution.) Suppose, however, that both the above perturbations are present: let the system be subjected to a load β applied at the center pin, and let α be the angle at which the spring exerts no torque. In this case the energy of the system becomes

$$V = \frac{1}{2}(x - \alpha)^2 + 2\lambda \cos x + \beta \sin x$$

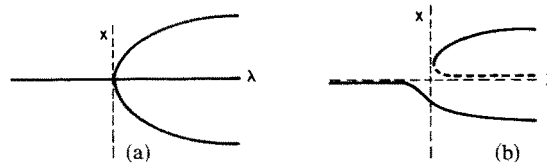

Figure 1.2. Bifurcation diagram of the Euler beam problem. (a) Idealized problem; (b) perturbed problem.

and, modulo terms of order x^4 , the condition for equilibrium becomes

$$(1.4) \quad 0 = \frac{\partial V}{\partial x} \approx \frac{1}{3}\lambda x^3 - \frac{1}{2}\beta x^2 + (1 - 2\lambda)x + (\beta - \alpha) = F(x, \lambda),$$

the latter equality being a definition. Our results below imply that the equation

$$(1.5) \quad F(x, \lambda) = 0$$

is contact equivalent to the exact equation $\partial V/\partial x = 0$, which justifies the neglect of the higher-order terms. (Note that the contact equivalence depends on α and β .) Provided $\alpha = \beta$, (1.5) continues to possess a bifurcating solution at $\lambda = \frac{1}{2}$, the non-trivial branch being given by

$$(1.6) \quad \frac{1}{3}\lambda x^2 - \frac{1}{2}\beta x + (1 - 2\lambda) = 0.$$

It may be seen from (1.6) that if $\beta \neq 0$ this bifurcation is transcritical, as indicated in Figure 1.3(a). Of course this diagram assumes the exact relation $\alpha = \beta$. A small perturbation of Figure 1.3 will in general lead to a disconnected diagram, which may be *either* of the type indicated in Figure 1.2(b) or in Figure 1.3(b). The difference between these two diagrams is readily observable physically—a system governed by Figure 1.3(b) can be made to exhibit hysteresis if λ is varied quasi-statically (i.e., slowly compared to the time for equilibrium to be obtained) back and forth across the interval containing the unstable solutions in the S part of the diagram. In particular this refines a suggestion of catastrophe theory (cf. [28]) that an arbitrary perturbation of the buckling beam problem may be described by one additional parameter.

Our theory is relevant for this and other bifurcation problems in several ways. In the first place it provides a rigorous justification for the truncation of the Taylor series by which (1.4) was derived. This allows the choice of normal forms for mappings which can substantially simplify calculations. Secondly, it shows that any other (smooth) perturbation whatsoever that might be put into the problem would not lead to qualitative behavior different from that

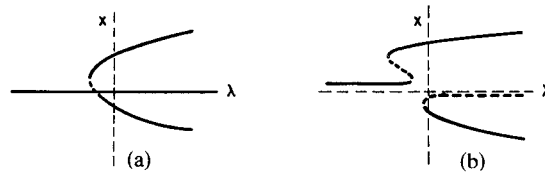

Figure 1.3. Diagram of bifurcation problem. (a) Transcritical bifurcation; (b) imperfect transcritical.

obtained by some choice of α and β in (1.4). This is true in the strict sense that the perturbed systems are contact equivalent to (1.4). Finally, the theory gives an algorithm for computing all the possible perturbed diagrams off of a given bifurcation problem. We shall describe the precise results of this algorithm for the above example in the next section.

It follows from Theorem 2.4 below that $\partial V(x, \lambda, \alpha, \beta)/\partial x$ is a universal unfolding of $\partial V(x, \lambda, 0, 0)/\partial x$. This means that any (smooth) perturbation whatsoever that might be added to the idealized problem would not lead to new qualitative behavior, to behavior not already present for the proposed two perturbations. The different stable diagrams that may result are enumerated by the regions in Figure 1.4. If (α, β) belongs to regions 1 or 3, the bifurcation diagram has the form of Figure 1.3(b) or its mirror image, respectively; if (α, β) belongs to regions 2 or 4, the diagram has the form of Figure 1.2(b) or its mirror image, respectively. Figure 1.3(a) illustrates diagrams that obtain when (α, β) lies on the ray separating regions 1 and 2, and Figure 1.5 corresponds to (α, β) on the curve separating regions 1 and 4; again the mirror image diagrams correspond to negative (α, β) . Rules for performing these calculations are given in Section 2.

It is clear that Figure 1.3(a) separates two regions of inequivalent diagrams—under perturbation the crossing at the center of this diagram can split in either of two ways. Figure 1.5 also represents a separating diagram because of the vertical tangent at P . A small perturbation of one sign yields a smooth solution branch $x(\lambda)$, while the opposite sign yields a hysteresis loop. We propose the name *hysteresis point* for such points which demarcate the onset of possible hysteresis.

Next consider a one-parameter family of perturbations G_ε of the idealized problem $\partial V(x, \lambda, 0, 0)/\partial x$. As will be shown, Theorem 2.4 also implies that, for each ε , G_ε is contact equivalent to $\partial V(x, \lambda, \alpha(\varepsilon), \beta(\varepsilon))/\partial x$ for some $(\alpha(\varepsilon), \beta(\varepsilon))$. Moreover, this assignment is smooth in ε and satisfies $(\alpha(0), \beta(0)) = (0, 0)$. Thus a one-parameter perturbation may be represented by a curve through the origin in α, β -space. Since the two separating curves in Figure 1.4 are tangent to second order, almost all curves will enter only regions 2 and 4. In order to observe regions 1 and 3 one must consider two

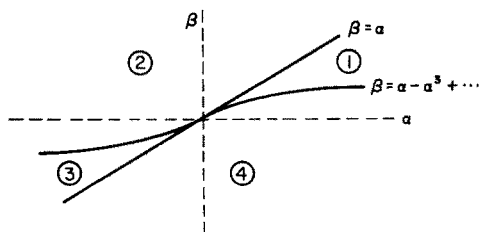

Figure 1.4. Illustration of the different stable diagrams that may result.

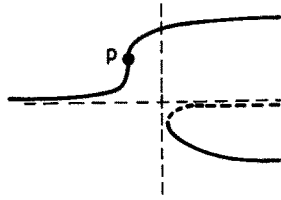

Figure 1.5. Illustration of diagrams that obtain when (α, β) lies on the curve separating regions 1 and 4.

parameter perturbations. This observation seems consistent with the engineering literature and is substantiated in that both perturbations considered above (i.e., initial curvature and a central load) yield diagrams from regions 2 and 4. The full picture is obtained only by considering both perturbations together.

c. Comparisons and comments. The starting point of the present paper was Christopher Zeeman's [28] attempt to relate the imperfect buckling of an Euler strut to catastrophe theory. Our results differ from Zeeman's, as stated in subsection b, in that we find that two imperfection parameters are necessary to describe an arbitrary small perturbation of this problem, while Zeeman suggests that one is sufficient. The explanation of this difference lies in our attitudes toward the bifurcation parameter λ . To be more specific, we consider an example, the bifurcation problem

$$(1.7) \quad x^3 - \lambda x = 0.$$

Obviously we may write (1.7) in the form $\partial V/\partial x = 0$, where $V_\lambda(x) = \frac{1}{4}x^4 - \frac{1}{2}\lambda x^2$. For Zeeman, (1.7) represents a one-parameter unfolding of the potential $\frac{1}{4}x^4$. By adding another parameter,

$$(1.8) \quad x^3 - \lambda x + \alpha = 0,$$

he obtains a universal unfolding of (1.7), *relative to a certain notion of equivalence* which is determined by the permissible changes of coordinates. *We maintain that the notion of equivalence implicit in the derivation of (1.8) is not appropriate for bifurcation theory.* Indeed, let us take the perturbation of (1.7)

$$(1.9) \quad x^3 - \lambda x + \beta x^2 = 0$$

suggested by our theory. On substituting $y = x + \frac{1}{3}\beta$ in (1.9) we find

$$(1.10) \quad y^3 - (\lambda + \frac{1}{3}\beta^2)y + (\frac{1}{3}\lambda\beta + \frac{2}{27}\beta^3) = 0.$$

We may write (1.10) in the form (1.8) if we change coordinates in λ by $\bar{\lambda} = \lambda + \frac{1}{3}\beta^2$ and if we define

$$(1.11) \quad \alpha = \frac{1}{3}\lambda\beta + \frac{2}{27}\beta^3.$$

In other words, the perturbed equation (1.9) may be factored through the universal unfolding (1.8) *provided* we mix the bifurcation parameter λ with the imperfection parameters. However, the mixing in (1.11) can change the nature of a bifurcation problem, which may be seen by observing that (1.8) for $\alpha \neq 0$ is associated with a bifurcation diagram of the type in Figure 1.2(a), while (1.9) for $\beta \neq 0$ is associated with the type of Figure 1.3(a). In our theory the dependence of λ is part of the data of the original problem; when imperfections are considered, we do not allow λ to be mixed with them.

Because of the attacks that have been directed at catastrophe theory recently, it seems appropriate to say that, in spite of our criticism above of [28], we feel this paper represents a positive contribution towards the understanding of imperfect bifurcation. Certainly it was fundamental in our own thinking on this problem.

Other authors, particularly Thompson and Hunt [26], have recognized that the dependence on λ should be included as part of the data of a bifurcation problem. Indeed, the differences between their list of elementary bifurcation problems and Thom's list of elementary catastrophes originate in precisely this point. In his theory of r - s unfoldings for a potential function, Wassermann [27] has considered a grouping of variables into a three-level hierarchy similar to ours. However, we believe Wassermann's theory is inappropriate for the discussion of imperfect bifurcation, in view of the following point. The simple bifurcation problem (1.7) has infinite codimension in his theory because for every $\lambda > 0$ the associated potential function $V_\lambda(x) = \frac{1}{4}x^4 - \frac{1}{2}\lambda x^2$ assumes its minimum at two distinct points. Our theory avoids this pitfall by focusing on the equation $\partial V/\partial x = 0$. Matkowsky and Reiss [17] have developed a technique based on matched asymptotic expansions for analyzing the effect of specific perturbations on a bifurcation diagram. This theory and ours complement each other, as we attempt to classify and to list all the inequivalent perturbation which can occur in a problem. Chow, Hale and Mallet-Paret [6] have discussed the effect of certain perturbations of a double eigenvalue, and the same comment is appropriate.

As the above discussion suggests, our work differs from previous applications of catastrophe theory in that we do not restrict our considerations to problems in variational form and we do assume the existence of a distinguished bifurcation parameter λ . It turns out that perturbing the equation rather than the potential leads to a more natural theory even in the case of bifurcation from a simple eigenvalue where a potential function is readily available if desired.

The main theoretical results of this paper are presented in Section 2 and proved in Section 3. In Sections 4 and 5 we apply the theory to model mathematical problems, bifurcation from a simple eigenvalue being discussed in Section 4 and from a double eigenvalue in Section 5. In Section 6 we analyze the continuous version of the Euler beam problem, showing that central load and unstressed curvature provide a universal unfolding of this problem. We have collected a number of instances of bifurcation problems of various types in Section 7. Finally in Section 8 we briefly discuss the potential case.

2. Statement of the Theorems

In this section we formulate mathematically precise versions of our results. We have nonetheless tried to make the exposition accessible to as wide an audience as possible. We begin with a careful definition of a universal unfolding of a bifurcation problem $G(x, \lambda)$. We remind the reader that such concepts exist only on the germ level—although we may write \mathbf{R}^n for the domain of a function, this is a shorthand for an unspecified small neighborhood of zero in \mathbf{R}^n . We use the notation $G : (\mathbf{R}^n \times \mathbf{R}, 0) \rightarrow (\mathbf{R}^m, 0)$ for a germ defined near zero such that $G(0, 0) = 0$.

DEFINITION 2.1a. An l -parameter unfolding of G is a C^∞ map $F : (\mathbf{R}^n \times \mathbf{R} \times \mathbf{R}^l, 0) \rightarrow (\mathbf{R}^m, 0)$ such that $F(x, \lambda, 0) = G(x, \lambda)$ for all x, λ .

An unfolding is the precise notion of imperfections we shall use in this paper. Usually we shall write F_α for the map $F(\cdot, \cdot, \alpha)$ with $\alpha \in \mathbf{R}^l$ held fixed. Intuitively, a universal unfolding is an unfolding F , say l -parameter, with the following property: for any other unfolding H , say k -parameter, there is a smooth map $\psi : \mathbf{R}^k \rightarrow \mathbf{R}^l$ such that, for every $\beta \in \mathbf{R}^k$, H_β is contact equivalent to $F_{\psi(\beta)}$. The parameters of the contact equivalence may depend on β —specifically we have the relation

$$(2.1b) \quad H_\beta(x, \lambda) = \tau_{x, \lambda, \beta} \cdot F_{\psi(\beta)}(\rho_\beta(x, \lambda), \Lambda_\beta(\lambda)),$$

where we require that τ , ρ and Λ all reduce to the appropriate identity when $\beta = 0$. If (2.1b) holds, we say that H factors through F , and we call ψ the factoring map.

DEFINITION 2.1c. F is a universal unfolding of G if every unfolding of G factors through F .

We shall call two l -parameter unfoldings F and H equivalent if (2.1b) holds with ψ a diffeomorphism on \mathbf{R}^l , and isomorphic if (2.1b) holds with ψ

the identity on \mathbf{R}^1 . Our definition of universal unfolding does not require that the number of unfolding parameters be minimal.

Our goal is to determine when G has a universal unfolding and to compute a universal unfolding if it exists. This is a standard problem in singularity theory, whose solution we sketched in the introduction. That is, given a mapping G , let \mathcal{O}_G be the set of germs contact equivalent to G . G has a universal unfolding if and only if \mathcal{O}_G is a "manifold" of finite codimension in the space of all germs (even though both are infinite-dimensional manifolds!). In the case of finite codimension, only perturbations that tend to move G away from the orbit \mathcal{O}_G are relevant for a universal unfolding, and there are only finitely many such (linearly independent) directions. Somewhat surprisingly, there is a completely manageable computational algorithm, in terms of the tangent space to the orbit \mathcal{O}_G , to determine whether these properties obtain.

On a naive level, the tangent space TG to the orbit \mathcal{O}_G at G consists of all mappings H such that $G + \varepsilon H$ is contact equivalent to G to first order in the small parameter ε , and the calculations below could be based on this point of view. More formally, TG equals the totality of derivatives $\partial G/\partial t|_{t=0}$ of curves $\{t \rightarrow G_t\}$ contained in \mathcal{O}_G and passing through G at $t=0$, in complete analogy with the finite-dimensional situation. (Note that G_t is simply a one-parameter unfolding of G .) Such a curve may be represented in the form

$$G_t = \tau_t \cdot G(\rho_t, \Lambda_t),$$

where τ_t , ρ_t and Λ_t all equal the appropriate identity when $t=0$. Here we have suppressed the dependence on (x, λ) ; restoring these variables would give a formula analogous to (2.1b). On differentiating with respect to t (using the dot notation) and setting $t=0$ we obtain

$$(2.2) \quad \dot{G} = \dot{\tau} \cdot G + d_x G \cdot \dot{\rho} + \frac{\partial G}{\partial \lambda} \dot{\Lambda},$$

where $\dot{\tau} = \partial \tau / \partial t|_{t=0}$ is an arbitrary matrix-valued function of (x, λ) , $\dot{\rho}$ is an arbitrary vector-valued function of (x, λ) , and $\dot{\Lambda}$ is an arbitrary scalar-valued function of λ only. Thus TG consists of all the mappings that may be obtained from (2.2) as $\dot{\tau}$, $\dot{\rho}$ and $\dot{\Lambda}$ vary.

The following algebraic interpretation of (2.2) is the basis for both the practical computation of TG and the theoretical analysis. Let \mathcal{E}_{n+1} be the ring of germs of real-valued functions on the $n+1$ variables (x, λ) , and regard \mathcal{E}_{n+1}^m , the space of m -tuples, as a module over \mathcal{E}_{n+1} with component-wise multiplication. We shall sometimes write $\mathcal{E}_{x,\lambda}$ for \mathcal{E}_{n+1} . Now consider in (2.2)

the first component of the product of the matrix $\dot{\tau}$ times the vector G , namely

$$\dot{\tau}_{1,1}G_1 + \cdots + \dot{\tau}_{1,m}G_m.$$

Since $\dot{\tau}_{ij}$ is an arbitrary function of (x, λ) , this term is an arbitrary element in the ideal $\langle G \rangle = \langle G_1, \dots, G_m \rangle$ in \mathcal{E}_{n+1} generated by the m components of G . The same considerations apply to the other components of $\dot{\tau} \cdot G$, and we may write $\dot{\tau} \cdot G \in \langle G \rangle^m$, the set of m -tuples. The second term in (2.2), the product of the matrix $d_x G$ times the vector function $\dot{\rho}$, may be written as

$$\dot{\rho}_1 \frac{\partial G}{\partial x_1} + \cdots + \dot{\rho}_n \frac{\partial G}{\partial x_n}.$$

It should be recalled here that $\partial G / \partial x_j$ is an m -vector. Since $\dot{\rho}_j$ is an arbitrary function of (x, λ) , we may say that the second term in (2.2) belongs to $\mathcal{E}_{n+1}\{\partial G / \partial x\}$, the submodule of \mathcal{E}_{n+1}^m generated by $\partial G / \partial x_1, \dots, \partial G / \partial x_n$ over the ring \mathcal{E}_{n+1} . For the third term in (2.2) we have only

$$\frac{\partial G}{\partial \lambda} \dot{\lambda} \in \mathcal{E}_\lambda \left\{ \frac{\partial G}{\partial \lambda} \right\} = \left\{ \phi(\lambda) \frac{\partial G}{\partial \lambda} \mid \phi \in \mathcal{E}_\lambda \right\},$$

since, by hypothesis, $\dot{\lambda}$ is independent of x . The third term is not associated with a submodule over the full ring \mathcal{E}_{n+1} , which is the reason for the distinction between TG and $\tilde{T}G$ in the following definition and the associated loss of elegance. In this definition and elsewhere \dim refers to the real dimension of a vector space.

DEFINITION 2.3. (i) Let $\tilde{T}G = \langle G \rangle^m + \mathcal{E}_{n+1}\{\partial G / \partial x\}$ and let $TG = \tilde{T}G + \mathcal{E}_\lambda\{\partial G / \partial \lambda\}$.

(ii) C has *finite codimension* if $\dim(\mathcal{E}_{n+1}^m / \tilde{T}G) < \infty$,

(iii) The *codimension of G* equals $\dim(\mathcal{E}_{n+1}^m / TG)$ and is denoted by $\text{codim } G$.

The first of our two principal theoretical results is the following.

THEOREM 2.4. *Suppose G has finite codimension, and let F_α be an l -parameter unfolding of G . F_α is a universal unfolding of G if and only if TG plus the l -vectors $\partial F / \partial \alpha_1|_{\alpha=0}, \dots, \partial F / \partial \alpha_l|_{\alpha=0}$ together span \mathcal{E}_{n+1}^m (over the reals). The minimum number of unfolding parameters in any universal unfolding is the codimension of G .*

This theorem plus the uniqueness result below will be proved in Section 3.

The following is a noteworthy consequence of this theorem: if $p_1(x, \lambda), \dots, p_l(x, \lambda)$ project onto a basis of the quotient \mathcal{E}_{n+1}^m/TG , then

$$F(x, \lambda, \alpha) = G(x, \lambda) + \sum_{j=1}^l \alpha_j p_j(x, \lambda)$$

is a universal unfolding of G with the minimum number of parameters. Of course in Theorem 2.4 it is not required that the imperfection parameters enter linearly.

PROPOSITION 2.5. *If F_α and E_β are any two universal unfoldings of G with the same number of parameters, then F_α and E_β are equivalent.*

EXAMPLE 2.6. Let us illustrate these concepts for a specific example, namely, $G(x, \lambda) = x^3 - \lambda x$. The bifurcation diagram associated with G is a pitchfork, and we show below that G is contact equivalent to the problem considered in the introduction. Since $m = 1$, the distinction between the ring \mathcal{E}_{n+1} and the module \mathcal{E}_{n+1}^m disappears. We have

$$\tilde{T}G = \langle x^3 - \lambda x, 3x^2 - \lambda \rangle,$$

the ideal in \mathcal{E}_{n+1} generated by these two functions. Observe that

$$x^3 = \frac{1}{2}x(3x^2 - \lambda) - \frac{1}{2}(x^3 - \lambda x) \in \tilde{T}G,$$

$$\lambda x = 3x^3 - x(3x^2 - \lambda) \in \tilde{T}G,$$

$$\lambda^2 = 3\lambda x^2 - \lambda(3x^2 - \lambda) \in \tilde{T}G.$$

Thus $\tilde{T}G$ contains the ideal $\langle x^3, \lambda x, \lambda^2 \rangle$. But $\mathcal{E}_2/\langle x^3, \lambda x, \lambda^2 \rangle$ has dimension 4, a basis consisting of (the projections of) $1, x, x^2, \lambda$. These four monomials are not independent in $\mathcal{E}_2/\tilde{T}G$, since the generator $(3x^2 - \lambda) \in \tilde{T}G$ provides a relation between them. There are no other relations, however, so $\dim(\mathcal{E}_2/\tilde{T}G) = 3$. One choice of basis is (the projections of) $1, x, x^2$. In particular, G has finite codimension.

To form TG from $\tilde{T}G$ we must consider all functions in

$$\mathcal{E}_\lambda \left\{ \frac{\partial G}{\partial \lambda} \right\} = \{ \phi(\lambda)x \mid \phi \in \mathcal{E}_\lambda \}.$$

If $\phi(0) = 0$, then $\phi(\lambda) = \lambda \hat{\phi}(\lambda)$ for some $\hat{\phi} \in \mathcal{E}_\lambda$, and $\hat{\phi}(\lambda)\lambda x \in \tilde{T}G$. Thus $\mathcal{E}_\lambda \{ \partial G / \partial \lambda \}$ only enlarges TG by one dimension, adding real multiples of x to

the space $\tilde{T}G$. Therefore, \mathcal{E}_2/TG has dimension 2, a possible basis being (the projections of) 1 and x^2 . This leads to the universal unfolding

$$F(x, \lambda, \alpha) = x^3 - \lambda x + \alpha_1 x^2 + \alpha_2.$$

With the help of the following lemma one can easily show that Example 2.6 is contact equivalent to the problem considered in the introduction. (See the example after Lemma 4.3 for a detailed description. The reader may omit the proof of this lemma without loss of continuity; we include it here for completeness.)

LEMMA 2.7. *Suppose $G(x, \lambda) = x^m - \lambda x$ and $H(x, \lambda) = x^m q(x) - \lambda x + x^2 \lambda a(x, \lambda) + \lambda^2 b(x, \lambda)$, where $m \geq 2$ and $q(0) > 0$. Then G and H are contact equivalent.*

Proof: First of all, by a simple change of coordinates in x we can put H into the same form with $q=1$. Next, we claim that $H(x, \lambda) = (x - c(\lambda)) \cdot (x^{m-1} d(x) - \lambda) e(x, \lambda)$, where $c(0) = 0$, $d(0) = 1$ and $e(0) > 0$. If this is true, then H is contact equivalent to $x((x + c(\lambda))^{m-1} f(x, \lambda) - \lambda)$, where $f(0) > 0$. (The contact equivalence is obtained by letting $\tau = 1/e$, $\rho_\lambda(x) = x + c(\lambda)$ and $\Lambda(\lambda) = \lambda$.) Using the fact that $c(0) = 0$, we may write the second factor as $x^{m-1} f(x, \lambda) - \lambda g(x, \lambda)$, where $g(0) = 1$. Dividing by g , we see that H is contact equivalent to $x(x^{m-1} h(x, \lambda) - \lambda)$, where $h(0) > 0$. Letting $\rho_\lambda(x) = h(x, \lambda)^{1/(m-1)} \cdot x$ yields that H is contact equivalent to $x(x^{m-1} - \lambda) = G(x, \lambda)$.

To prove the claim consider that $H(x, x^{m-2} \mu) = x^{m-1} L(x, \mu)$, where $L(0) = 0$ and $\partial L(0)/\partial \mu = -1$. By the implicit function theorem there exists a unique function $\mu(x)$ with $\mu(0) = 0$ such that $H(x, x^{m-2} \mu(x)) \equiv 0$. Letting $\mu(x) = x d(x)$ we see that $H(x, x^{m-1} d(x)) \equiv 0$ implies that $d(0) = 1$. Now we have $H(x, \lambda) = (x^{m-1} d(x) - \lambda) K(x, \lambda)$. Evaluating at $\lambda = 0$ shows that $K(0) = 0$ and $\partial K(0)/\partial x \neq 0$. Again the implicit function theorem implies the existence of a unique function $c(\lambda)$ with $K(c(\lambda), \lambda) \equiv 0$ and $c(0) = 0$. Consequently, we have that $H(x, \lambda) = (x^{m-1} d(x) - \lambda)(x - c(\lambda)) e(x, \lambda)$. Finally note that $e(0) = 1$ since $H(x, 0) = x^m$.

The next proposition gives a more theoretical criterion for when two bifurcation problems are contact equivalent. A bifurcation problem $G : (\mathbf{R}^n \times \mathbf{R}, 0) \rightarrow (\mathbf{R}^m, 0)$ is called *k-determined* if any other problem whose Taylor expansion at the origin agrees with the expansion of G through terms of order k is contact equivalent to G . G is called *finitely determined* if it is *k-determined* for some k . For any integer k let $\mathcal{M}^k \subset \mathcal{E}_{n+1}$ be the k -th power of maximal ideal in \mathcal{E}_{n+1} (i.e., \mathcal{M} is the set of all functions vanishing at the origin); then $\mathcal{M}^k \mathcal{E}_{n+1}^m$ consists of the germs whose Taylor expansions vanish to order k at the origin.

THEOREM 2.8. (i) If $\mathcal{M}^k \mathcal{E}_{n+1}^m \subset \mathcal{M}\tilde{T}G$, then G is k -determined. (ii) If G has finite codimension, then G is finitely determined.

Part (ii) of the theorem follows from (i) because if $\dim(\mathcal{E}_{n+1}^m/\tilde{T}G) < \infty$, then $\mathcal{M}^k \mathcal{E}_{n+1}^m \subset \tilde{T}G$ for some k ; thus G will be $(k+1)$ -determined. Part (i) is proved in Section 3. Several applications of this result are made in Sections 4 and 5. The following corollary is an immediate consequence of the theorem. This corollary is often useful in simplifying calculations.

COROLLARY 2.9. A bifurcation problem of finite codimension is contact equivalent to a map all of whose entries are polynomials. Such a map admits a universal unfolding that is also a polynomial mapping (in all variables).

We turn now to the second principal theoretical issue of this paper, to determine all the possible inequivalent bifurcation diagrams that can occur in the universal unfolding $F(x, \lambda, \alpha)$ of a given problem. In this discussion we assume $m = n$. As mentioned in the introduction, there are three ways a diagram can fail to be stable, which are illustrated in Figure 2.1. The first of these, for which the name bifurcation has traditionally been reserved, is the most obviously unstable—a small perturbation will in general split the diagram into two smooth components. The second diagram, which was also encountered in the introduction, is unstable for the following reason: although in Figure 2.1(b) there is precisely one solution point for each λ , an arbitrarily small perturbation of the right sign will produce an S shaped diagram for which there are three solution points for each λ close to the origin. More generally, if the order of contact of a solution branch with the vertical slice $\{\lambda = \text{constant}\}$ is greater than or equal to 2, hysteresis loops can be established by a small perturbation. We use the term *hysteresis point* to refer to all of these possibilities. In Figure 2.1(c) the name *limit point* is Thompson and Hunt's term for a point on a smooth solution branch where λ assumes a non-degenerate extremum value; that is, the order of contact with the vertical slice is 1. If, as in this diagram, two (or more) limit points occur in the same plane $\{\lambda = \text{constant}\}$, an unstable diagram obtains. Specifically in Figure 2.1(c) there are two solutions for each λ but in general after perturbation the two limit points will not lie in the same λ -slice and the number of solutions as a function of λ will be different. We include in this case the similar case of two limit points in the same plane $\{\lambda = \text{constant}\}$ whose solution branches both open in the same direction.

Let us derive necessary conditions for unstable diagrams of each of the three kinds to occur. For Figure 2.1(a) this is trivial—since the zero set of F is not a manifold, we must have $\text{rank } dF < n$. Here dF is the differential of F with respect to x and λ but not α . Thus a diagram with bifurcation can occur

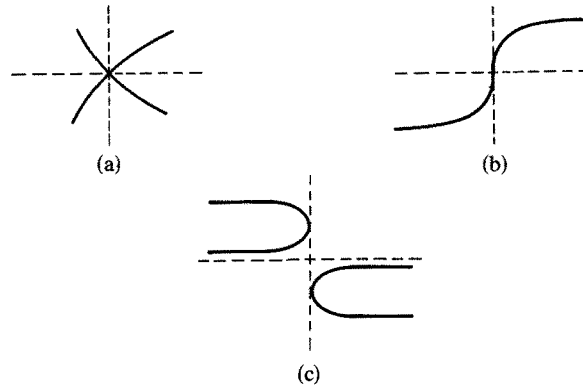

Figure 2.1. Illustration of the three ways in which a diagram can fail to be stable. (a) Bifurcation point; (b) hysteresis point; (c) double limit point.

only if α belongs to the set

$$(2.10) \quad B = \{ \alpha \mid \exists (x, \lambda) \text{ with } F(x, \lambda, \alpha) = 0 \text{ and rank } dF < n \}.$$

We may suppose without loss of generality that F is a polynomial mapping, so that the equations in (2.10) will be algebraic. The rank condition on a $n \times (n+1)$ matrix is equivalent to two scalar equations; thus (2.10) is a system of $n+2$ equations in $n+1+l$ variables (x, λ, α) . On elimination of x and λ we are left with a single semi-algebraic equation in the l variables $\alpha \in \mathbf{R}^l$. In summary, the diagram associated to F_α will not contain any bifurcation points unless α belongs to the algebraic surface (2.10).

It may happen that a given diagram is singular in two or more of the above ways. Notice, however, that any diagram with bifurcation will appear in (2.10), regardless of other singularities that may be present. Since our goal is only to derive necessary conditions for a diagram to be unstable, in treating case (b) we may assume without loss of generality that no bifurcation is present, i.e., that $\text{rank } dF = n$. This means that the bifurcation diagram is a smooth curve, say $\{(x(\tau), \lambda(\tau)) \mid \tau \in \mathbf{R}\}$. It may be seen from Figure 2.1(b) that $\lambda'(0) = \lambda''(0) = 0$; of course we require that $x'(0) \neq 0$, calling this vector v . On differentiating the relation $F(x(\tau), \lambda(\tau), \alpha) \equiv 0$ we obtain the relations

$$(2.11) \quad \begin{aligned} d_x F \cdot v &= 0, \\ d_x^2 F(v, v) &\in \text{range } d_x F. \end{aligned}$$

Here $d_x F$ and $d_x^2 F$ are the first and second differentials of F with respect to x .

Thus α must belong to the set

$$(2.12) \quad H = \{ \alpha \mid \exists(x, \lambda) \text{ with } F(x, \lambda, \alpha) = 0, \det d_x F = 0, \\ d_x^2 F(v, v) \in \text{range } d_x F \},$$

where v is any non-zero vector in $\ker d_x F$, necessarily nontrivial. The range condition is effectively one equation if $\ker d_x F$ is one-dimensional. Thus (2.12) is effectively a system of $n+2$ equations in $n+1+l$ unknowns. Elimination of x and λ leaves a single semi-algebraic equation in α .

It is clear that there can be two limit points in the same λ -slice only if α belongs to

$$(2.13) \quad DL = \{ \alpha \mid \exists(x, y, \lambda) \text{ with } x \neq y, F(x, \lambda, \alpha) = 0 = F(y, \lambda, \alpha), \text{ and} \\ \det(d_x F)(x, \lambda, \alpha) = 0 = \det(d_x F)(y, \lambda, \alpha) \}$$

An equation count shows that (2.13) is effectively a single equation in α .

Suppose G is a bifurcation problem with finite codimension and F is a universal unfolding of G . Let C (for *control set*) be the union of the three algebraic surfaces (2.10), (2.12) and (2.13). We show in Section 3 that $\mathbf{R}^l \sim C$ is non-empty and therefore everywhere dense. On an intuitive level the theorem below states that F_α is stable if $\alpha \in \mathbf{R}^l \sim C$. However, care must be exercised in formulating this result because so far we have been working with germs of mappings. Thus for example the bifurcation problem G is equivalent to its restriction to an arbitrarily small neighborhood of the origin. In this theorem we revoke this convention which is usually employed when dealing with germs. Instead, we consider $F : U \times V \rightarrow \mathbf{R}^n$ to be defined on a *fixed open neighborhood of the origin* in $\mathbf{R}^n \times \mathbf{R} \times \mathbf{R}^l$, where $U \subset \mathbf{R}^n \times \mathbf{R}$ and $V \subset \mathbf{R}^l$.

DEFINITION 2.14. (a) Suppose $G, H : U \rightarrow \mathbf{R}^n$ are two bifurcation problems. Given a neighborhood $U' \subset U$ we shall say that G is *equivalent to H on U'* if (1.2) holds for all (x, λ) in U' .

(b) If $\alpha \in V$, we say that $F_\alpha : U \rightarrow \mathbf{R}^n$ is (F, U') -stable if F_α is equivalent to F_β on U' for all β near α .

Note that we use the unfolding itself to parametrize the perturbations of G —although every perturbation may be so parametrized, the parametrization is not uniform and technical complications are avoided by this ruse.

THEOREM 2.15. *In terms of the notation above, there exist open neighborhoods of zero U' and V' in $\mathbf{R}^n \times \mathbf{R}$ and \mathbf{R}^l , respectively, with $U' \subset U$ and $V' \subset V$, such that F_α is (F, U') -stable for all $\alpha \in V' \sim C$.*

COROLLARY 2.16. *Let G and F be as in Theorem 2.15. For α and β in the same connected component of $V' \sim C$, F_α is contact equivalent to F_β on U' . Thus all diagrams associated with a given connected component are equivalent.*

Proof: Theorem 2.15 states that the equivalence classes of the F_α for α in a given connected component are open. Connectedness implies that there is but one equivalence class.

This theorem is proved in Section 3. One may use it to justify the interpretation of Figure 1.4 given in the introduction. Let us consider, however, the slightly simpler problem $G(x, \lambda) = x^3 - \lambda x$, which by Lemma 2.7 is contact equivalent to the earlier problem. We choose the universal unfolding

$$F(x, \lambda, \alpha) = x^3 - \lambda x + \alpha_1 x^2 + \alpha_2.$$

The equations for (2.10) reduce to the system

$$F = \frac{\partial F}{\partial x} = \frac{\partial F}{\partial \lambda} = 0;$$

when x and λ are eliminated we are left with the equation

$$(2.17) \quad \alpha_2 = 0.$$

The equations for (2.12) reduce to

$$F = \frac{\partial F}{\partial x} = \frac{\partial^2 F}{\partial x^2} = 0,$$

which on elimination of x and λ yield

$$(2.18) \quad \alpha_2 = \frac{1}{27} \alpha_1^3.$$

The equations for (2.13) have no solutions in this case. In conclusion, the values of α for which F_α is not stable are located on two smooth curves that intersect and are tangent to second order at the origin. These two curves divide the plane into four regions, and for α inside these regions F_α is stable. To determine the qualitative type of diagrams in each region, it suffices to compute one representative explicitly. This completes the explanation of Figure 1.4 and its interpretation, apart from the remark that Figure 1.4 is rotated 45° and reflected as compared to the curves (2.17), (2.18) because of a different choice of unfolding parameters.

3. The Proofs

In this section we adapt standard proofs of the unfolding theorem and finite determinacy to prove the theorems stated in Section 2. For the proof of the unfolding theorem we follow Martinet's excellent exposition [15].

The idea of the proof is as follows. Given G and F as in the statement of Theorem 2.4, let $H_s(x, \lambda)$ be a k -parameter unfolding of G . To show that H is a universal unfolding of G we must show that H factors through F . To do this we form the sum unfolding $S_{\alpha,s}(x, \lambda) = F_\alpha(x, \lambda) + H_s(x, \lambda) - G(x, \lambda)$. The object of the proof will be to show that $S_{\alpha,s}$ factors through the unfolding of G obtained by setting one of the s -variables in $S_{\alpha,s}$ equal to 0. Using the argument inductively we show that $S_{\alpha,s}$ factors through F_α . Finally, restricting the factoring map so constructed to $\alpha = 0$ in $S_{\alpha,s}$ yields a factoring of the unfolding H_s through F_α as desired. Lemma 3.1 isolates the argument necessary in the reduction step. The other preliminary results give the form of the Malgrange preparation theorem needed in the proof of the unfolding theorem. First, some notation.

Let $F : (\mathbf{R}^n \times \mathbf{R} \times \mathbf{R}^l, 0) \rightarrow (\mathbf{R}^m, 0)$ be an l -parameter unfolding of G . A usual set $F_\alpha(x, \lambda) = F(x, \lambda, \alpha)$ with $\alpha_1, \dots, \alpha_l$ denoting the α -coordinates. Let \mathbf{R}^{l-1} denote the space $\{\alpha_l = 0\}$. Let E denote the $(l-1)$ -parameter unfolding of G obtained by restricting F to $\mathbf{R}^n \times \mathbf{R} \times \mathbf{R}^{l-1}$. Next let $h : (\mathbf{R}^k, 0) \rightarrow (\mathbf{R}^l, 0)$ be a smooth germ. Denote by h^*F the k -parameter unfolding of G defined by $(h^*F)(x, \lambda, \beta) = F_{h(\beta)}(x, \lambda)$. Finally, recall that the germ h is a *submersion* if $(dh)_0$ is onto and that two l -parameter unfoldings F and H of G are *isomorphic* if H can be factored through F in such a way that the factorizing map is the identity map.

LEMMA 3.1. (The Reduction Lemma). *The following are equivalent:*

(a) *there exists a submersion $h : (\mathbf{R}^l, 0) \rightarrow (\mathbf{R}^{l-1}, 0)$ such that F is isomorphic to h^*E if and only if*

(b) *there exists a vector field X on $\mathbf{R}^n \times \mathbf{R} \times \mathbf{R}^l$ of the form*

$$X = \frac{\partial}{\partial \alpha_l} + \sum_{i=1}^{l-1} \xi_i(\alpha) \frac{\partial}{\partial \alpha_i} + a(\lambda, \alpha) \frac{\partial}{\partial \lambda} + \sum_{j=1}^n X_j(x, \lambda, \alpha) \frac{\partial}{\partial x_j}$$

and a parametrized family of vector fields $Y_{x,\lambda,\alpha}$ on \mathbf{R}^m such that $() (dF)(X) = Y_{x,\lambda,\alpha} \circ F$, where (dF) is the Jacobean matrix obtained by differentiation with respect to x, λ and α .*

Proof: (a) \Rightarrow (b) is left to the reader since we shall only need (b) \Rightarrow (a). Integrating the vector field X yields a one-parameter group of diffeomorphisms $(\rho_{\alpha_i}(x, \lambda, \alpha), \Lambda_{\alpha_i}(\lambda), h_{\alpha_i}(\alpha))$. Note that the time parameter may be taken to be α_l since the coefficient of X on $\partial/\partial \alpha_l$ is identically one. This also implies

that the integral curves of X are transverse to $\{\alpha_l = 0\}$. Define a submersion of $(\mathbf{R}^n \times \mathbf{R} \times \mathbf{R}^l, 0) \rightarrow (\mathbf{R}^n \times \mathbf{R} \times \mathbf{R}^{l-1}, 0)$ by projecting (x, λ, α) along the integral curves of X until $\alpha_l = 0$. This map has the form $(x, \lambda, \alpha) \rightarrow (\rho_{\lambda, \alpha}(x), \Lambda_\alpha(\lambda), h(\alpha))$, where, for each (α, λ) , $\rho_{\lambda, \alpha}$ is a diffeomorphism on \mathbf{R}^n , Λ_α is a diffeomorphism on \mathbf{R} and $h : (\mathbf{R}^l, 0) \rightarrow (\mathbf{R}^{l-1}, 0)$ is a submersion.

Next integrate the vector fields $Y_{x, \lambda, \alpha}$ to obtain a family of diffeomorphisms $\tau_{x, \lambda, \alpha, t}$ on \mathbf{R}^m . As before identify the time parameter t with α_l and note that (*) implies that integral curves of X are mapped to integral curves of Y . Hence, $E_{h(\alpha)}(\rho_{\lambda, \alpha}(x), \Lambda_\alpha(\lambda)) = \tau_{x, \lambda, \alpha}(F_\alpha(x, \lambda))$. Thus

$$h^*E(x, \lambda, \alpha) = \tau_{x, \lambda, \alpha}(F_\alpha(\rho_{\alpha, \lambda}^{-1}(x), \Lambda_\alpha^{-1}(\lambda))).$$

Finally, apply Lemma 1.3 to see that for contact equivalence the diffeomorphism $\tau_{x, \lambda, \alpha}$ may be replaced by linear maps. So that h^*E is isomorphic to F .

Recall that \mathcal{M}_α denotes the maximal ideal in \mathcal{E}_α consisting of germs which vanish at 0 in \mathbf{R}^l .

PROPOSITION 3.2. *Let N be a finitely generated module over $\mathcal{E}_{x, \lambda, \alpha}$. Let $N_0 = N/\mathcal{M}_\alpha N$. For n in N denote by \tilde{n} the projection of n in N_0 . Then*

$$(a) \quad \mathcal{E}_\alpha\{n_1, \dots, n_t\} = N \quad \text{if and only if} \quad (b) \quad \mathbf{R}\{\tilde{n}_1, \dots, \tilde{n}_t\} = N_0.$$

Proof: This is just Proposition 2.1 of [15] with the submodule assumed to be 0.

LEMMA 3.3. *Let $F : (\mathbf{R}^n \times \mathbf{R} \times \mathbf{R}^l, 0) \rightarrow (\mathbf{R}^m, 0)$ be an unfolding of $G : (\mathbf{R}^n \times \mathbf{R}, 0) \rightarrow (\mathbf{R}^m, 0)$. Assume that G has finite codimension. Let q_1, \dots, q_r be in $\mathcal{E}_{x, \lambda, \alpha}^m$ with $q_{i,0} = q_i | \mathbf{R}^n \times \mathbf{R} \times \{0\}$. Then*

$$(a) \quad \langle G \rangle^m + \mathcal{E}_{x, \lambda}\{\partial G/\partial x\} + \mathcal{E}_\lambda\{\partial G/\partial \lambda\} + \mathbf{R}\{q_{1,0}, \dots, q_{r,0}\} = \mathcal{E}_{x, \lambda}^m$$

if and only if

$$(b) \quad \langle F \rangle^m + \mathcal{E}_{x, \lambda, \alpha}\{\partial F/\partial x\} + \mathcal{E}_{\lambda, \alpha}\{\partial F/\partial \lambda\} + \mathcal{E}_\alpha\{q_1, \dots, q_r\} = \mathcal{E}_{x, \lambda, \alpha}^m.$$

Note. (a) just states that $TG + \mathbf{R}\{q_{1,0}, \dots, q_{r,0}\} = \mathcal{E}_{x, \lambda}^m$.

Proof: Since G has finite codimension we can write $TG = \tilde{T}G + \mathbf{R}\{p_1, \dots, p_s\}$. Let N be the $\mathcal{E}_{x, \lambda, \alpha}$ module $\mathcal{E}_{x, \lambda, \alpha}^m / (\langle F \rangle^m + \mathcal{E}_{x, \lambda, \alpha}\{\partial F/\partial x\})$. Apply Proposition 3.2 with the generators $q_1, \dots, q_r, p_1, \dots, p_s$ to obtain (a) \Rightarrow (b). (b) \Rightarrow (a) is clear.

Proof of Theorem 2.4: Let $F^i = \partial F/\partial \alpha_i |_{\alpha=0}$. It is easy to show that if F is a universal unfolding of G , then $\mathcal{E}_{n+1}^m = TG + \mathbf{R}\{F^1, \dots, F^l\}$. We now prove the converse. Let F, G, H and S be as described above. As noted, S is a

$(k+l)$ -parameter unfolding of G . To prove the theorem it is sufficient to find a submersion $h : \mathbf{R}^l \times \mathbf{R}^k \rightarrow \mathbf{R}^l$ so that S is isomorphic to h^*F . We shall find h by induction on k .

We assume that F satisfies $\mathcal{E}_{x,\lambda}^m = TG + \mathbf{R}\{F^1, \dots, F^l\}$. Let $m_i(x, \lambda, \alpha, s) = \partial S_{\alpha,s}(x, \lambda) / \partial \alpha_i$. Then $m_{i,0} = F^i$ in the notation of Lemma 3.3. Applying Lemma 3.3 to S we see that

$$\langle S \rangle^m + \mathcal{E}_{x,\lambda,\alpha,s} \langle \partial S / \partial x \rangle + \mathcal{E}_{\lambda,\alpha,s} \langle \partial S / \partial \lambda \rangle + \mathcal{E}_{\alpha,s} \{m_1, \dots, m_r\} = \mathcal{E}_{x,\lambda,\alpha,s}^m.$$

Hence we can write

$$\frac{\partial S}{\partial s_k} = Y_{x,\lambda,\alpha,s}(S) + \sum_{i=1}^n X_i(x, \lambda, \alpha, s) \frac{\partial S}{\partial x_i} + \Lambda_{\alpha,s}(\lambda) \frac{\partial S}{\partial \lambda} + \sum_{i=1}^l \xi_i(\alpha, s) \frac{\partial S}{\partial \alpha_i}.$$

Let

$$X = \frac{\partial}{\partial s_k} - \sum_{i=1}^l \xi_i(\alpha, s) \frac{\partial}{\partial \alpha_i} - \sum_{j=1}^n X_j(x, \lambda, \alpha, s) \frac{\partial}{\partial x_j}.$$

Then $(dS)(X) = Y \circ S$ and we can apply the Reduction Lemma to find a submersion $h : \mathbf{R}^l \times \mathbf{R}^k \rightarrow \mathbf{R}^l \times \mathbf{R}^{k-1}$ with the desired property. Thus the induction holds.

We now prove the uniqueness result.

Proof of Proposition 2.5: First we assume that $k = l$, where $l = \text{codim } G$. Since F_α is a universal unfolding of G , E_β factors through F_α . Hence $E_\beta(x, \lambda) = \tau_{x,\lambda,\beta} \cdot F_{\psi(\beta)}(\rho_\lambda(x), \Lambda(\lambda))$. We must show that the factoring map $\psi(\beta)$ is the germ of a diffeomorphism. It is sufficient to show that $(d\psi)(0)$ is invertible. Note that $E_\beta(x, \lambda)$ is equivalent to the unfolding $H_\beta(x, \lambda) = F_{\psi(\beta)}(x, \lambda)$. Thus H is a universal unfolding of G . Next one computes the initial speed vectors H^i in terms of the initial speeds F^i yielding

$$(3.4) \quad H^i = \frac{\partial \psi^1}{\partial \beta_i}(0) F^1 + \dots + \frac{\partial \psi^l}{\partial \beta_i}(0) F^l.$$

Since the F^i and H^i both must span l -dimensional spaces (using the fact that $l = \text{codim } G$ and Theorem 2.4), the matrix $(d\psi)(0)$ is invertible.

Next assume that E is a k -parameter unfolding and let L be an l -parameter universal unfolding. As before E factors through L with factoring map ψ . So $H_\beta = L_{\psi(\beta)}$ is a k -parameter universal unfolding of G when the factoring map $\psi : (\mathbf{R}^k, 0) \rightarrow (\mathbf{R}^l, 0)$. Now (3.4) (with L replacing F) implies that $\text{rank } (d\psi)(0) = l$ so that ψ is a submersion. Thus, E is equivalent to the k -parameter unfolding $K_{\psi(\beta)}$.

Finally, if F_α is another k -parameter universal unfolding of G , then F is also equivalent to an unfolding $K_{\phi(\alpha)}$, where $\phi : (\mathbf{R}^k, 0) \rightarrow (\mathbf{R}^l, 0)$ is a submersion. The implicit function theorem gives the existence of a diffeomorphism $\sigma : (\mathbf{R}^k, 0) \rightarrow (\mathbf{R}^k, 0)$ so that $\phi(\sigma(\beta)) = \psi(\beta)$. Hence, $K_{\phi(\alpha)}$ and $K_{\psi(\beta)}$ are equivalent unfoldings and then E_β and F_α are also equivalent.

To show finite determinacy one must analyse the following problem: let $G(x, \lambda)$ be a bifurcation problem and $P(x, \lambda)$ some small perturbation term. Given G , what conditions must be put on P to show that $G + P$ is contact equivalent to G ? There is a standard method. Let $G_t = G + tP$. Assume that G_t is contact equivalent to G , differentiate this relationship with respect to t , solve the resulting linear problem, and finally integrate to obtain the contact equivalence. Thus we assume

$$(3.5) \quad G(x, \lambda) = \tau_{x, \lambda, t} \cdot G_t(\rho_{\lambda, t}(x), \Lambda_t(\lambda)).$$

Differentiating (3.5) with respect to t (indicated by $\dot{\cdot}$) we obtain

$$(3.6) \quad 0 = \dot{\tau}_{x, \lambda, t} \cdot G_t(\rho_{\lambda, t}(x), \Lambda_t(\lambda)) + \tau_{x, \lambda, t} P(\rho_{\lambda, t}(x), \Lambda_t(\lambda)) \\ + \tau_{x, \lambda, t} \left[d_x G_t(\rho_{\lambda, t}(x), \Lambda_t(\lambda)) \dot{\rho}_{\lambda, t}(x) + \frac{\partial G_t}{\partial \lambda}(\rho_{\lambda, t}(x), \Lambda_t(\lambda)) \dot{\Lambda}_t(\lambda) \right].$$

Evaluate (3.6) at $(\rho_{\lambda, t}^{-1}(x), \Lambda_t^{-1}(\lambda))$ and multiply by $\tau_{x, \lambda, t}^{-1}$ to obtain

$$(3.7) \quad -P(x, \lambda) = T(x, \lambda, t) \cdot G_t(x, \lambda) + d_x G_t(x, \lambda) \cdot R(x, \lambda, t) \\ + L(\lambda, t) \frac{\partial G_t}{\partial \lambda}(x, \lambda),$$

where

$$L(\lambda, t) = \dot{\Lambda}_t(\Lambda_t^{-1}(\lambda)),$$

$$R(x, \lambda, t) = \rho_{\Lambda^{-1}(\lambda), t}(\dot{\rho}_{\Lambda^{-1}(\lambda), t}(x)),$$

and

$$T(x, \lambda, t) = \tau_{\rho_{\lambda, t}^{-1}(x), \Lambda_t^{-1}(\lambda), t}^{-1} \cdot \tau_{\rho_{\lambda, t}(x), \Lambda_t(\lambda), t}.$$

Note that L is a scalar, R is a vector, and T is a matrix-valued function.

LEMMA 3.8. *Suppose that (3.7) can be solved for R , L , and T with $L(0, t) \equiv 0$ and $R(0, 0, t) \equiv 0$; then $P + G$ is contact equivalent to G .*

Proof: First solve $d\Lambda_t(\lambda)/dt = L(\Lambda_t(\lambda), t)$. Since $L(0, t) \equiv 0$, we can solve this ordinary differential equation up to $t = 1$ on some small neighborhood of 0 in λ . This defines the germ Λ_t .

Next solve $d\rho_{\lambda,t}(x)/dt = R(\rho_{\lambda,t}(x), \Lambda_t(\lambda), t)$. Again since $R(0, 0, t) = 0$, we can solve for ρ up to $t = 1$ on some fixed neighborhood of 0 in x, λ -space. This defines the germs $\rho_{\lambda,t}$.

Finally solve the linear system of ordinary differential equations

$$\frac{d\tau_{x,\lambda,t}}{dt} = \tau_{x,\lambda,t} \cdot T(\rho_{\lambda,t}(x), \Lambda_t(\lambda), t).$$

There are no impediments to solving this equation up to $t = 1$. Now having defined Λ , ρ and τ , we can transform (3.7) to (3.6) and integrate (3.6) with respect to t to obtain (3.5).

We have now reduced the problem of determining whether $G + P$ is contact equivalent to G to solving the linear problem (3.7) subject to the constraints in Lemma 3.8. For our purposes it will suffice to find conditions on P to solve (3.7) with $L \equiv 0$. Note that a necessary condition is obtained by taking $t = 0$. Therefore we assume

$$(3.9) \quad P(x, \lambda) = T(x, \lambda) \cdot G(x, \lambda) + d_x G(x, \lambda) \cdot R(x, \lambda)$$

with $R(0) = 0$.

Clearly if we can write G and $d_x G$ as linear combinations of G_t and $d_x G_t$, then (3.9) would imply (3.7). We now find such a condition on P to guarantee this. To do this we inspect (3.9) more closely. Let $G_{i,j}$ denote the vector in \mathcal{E}_{n+1}^m whose j -th component is G_i .

As before let $\hat{T}G$ be the $\mathcal{E}_{x,\lambda}$ submodule of $\mathcal{E}_{x,\lambda}^m$ given by $\langle G \rangle^m - \mathcal{E}_{x,\lambda} \{ \partial G / \partial x_1, \dots, \partial G / \partial x_n \}$. Then $\hat{T}G$ is finitely generated with generators G and $\partial G / \partial x_i$. Equation (3.9) just states that P is in $\hat{T}G$.

LEMMA 3.10. (Nakayama) *Let N be a finitely generated E_x module with generators g_1, \dots, g_k . Suppose n_1, \dots, n_k are in N and m_1, \dots, m_k are in \mathcal{M}_x . Let $\bar{g}_i = g_i + m_i n_i$. Then $\bar{g}_1, \dots, \bar{g}_k$ also form a set of generators for N .*

Proof: Let $n_i = \sum_{j=1}^k a_{ij} g_j$ for a_{ij} in \mathcal{M}_x . Then we obtain

$$\begin{pmatrix} \bar{g}_1 \\ \vdots \\ \bar{g}_k \end{pmatrix} = (I_k + A) \begin{pmatrix} g_1 \\ \vdots \\ g_k \end{pmatrix},$$

where A is the matrix whose entries are $m_i a_{ij}$. Since $A(0) = 0$, we know the

$I_k + A$ is invertible near $x=0$. Hence the g_i may be written as linear combination of the \bar{g}_j and the \bar{g}_j generate N .

PROPOSITION 3.11. *Assume that P and $\partial P/\partial x_i$, $i=1, \dots, n$, are all in $\mathcal{M}_{x,\lambda} \tilde{T}G$. Then $G+P$ is contact equivalent to G .*

Proof: We claim that $(G_t)_{i,j}$ and $\partial G_t/\partial x_i$ form a set of generators for $\tilde{T}G$. Since $G_t = G + tP$, this follows from Lemma 3.10 and the assumptions, meaning that G and $d_x G$ are linear combinations of G_t and $d_x G_t$. As noted before, this is enough for (3.9) to imply (3.7). Now apply Lemma 3.8.

Note. The proof of Proposition 3.11 rests on the invertibility of the matrix $I_k + A$ in Nakayama's lemma. This invertibility was guaranteed since our hypotheses implied that $A(0)=0$. In certain applications we shall show the invertibility of $I_k + A$ directly. To do this we shall need to write explicitly the $m^2 + n$ equations relating the generators G_{ij} and $\partial G/\partial x_i$ to $G_{i,j,t}$ and $\partial G_t/\partial x_i$. When m and n are small this is not so hard. For example, if $n = m = 1$, the equations are

$$P = aG + b \frac{\partial G}{\partial x},$$

$$\frac{\partial P}{\partial x} = cG + d \frac{\partial G}{\partial x}.$$

In this case we need only show that the matrix $t \begin{pmatrix} a & b \\ c & d \end{pmatrix} - I_2$ is invertible at $(x, \lambda) = 0$. We shall use this observation in Section 4.

Proof of Theorem 2.8. (i): We assume that $\mathcal{M}^k \mathcal{E}_{x,\lambda}^m \subset \mathcal{M} \tilde{T}G$. Let $\bar{G} = G + P$, where P is in $\mathcal{M}^{k+1} \mathcal{E}_{x,\lambda}^m$. Then $\partial P/\partial x_i$ is in $\mathcal{M}^k \mathcal{E}_{x,\lambda}^m$. Hence $P, \partial P/\partial x_1, \dots, \partial P/\partial x_n$ are in $\mathcal{M} \tilde{T}G$ and we may apply Proposition 3.11.

We now prove Theorem 2.15. Recall that we consider only the case $m = n$. Let $G : U \rightarrow \mathbf{R}^n$ be a bifurcation problem where U is a neighborhood of 0 in $\mathbf{R}^n \times \mathbf{R}$. We assume that the germ of G at 0 is of finite codimension and that $F : U \times V \rightarrow \mathbf{R}^n$, where V is a neighborhood of 0 in \mathbf{R}^l is an unfolding of G . We also assume that the germ of F at 0 is a universal unfolding of the germ G . Let C be the control set of F_α in V . Our object is to show that there are neighborhoods $V' \subset V$ and $U' \subset U$ such that, for all α in $V' \sim C$, F_α is (F, U') stable (recall Definition 2.14). We choose V' in Lemma 3.12, characterize limit points in the next two lemmas and then prove the theorem. We wish to thank John Mather for supplying us with the following proof.

LEMMA 3.12. *Let $G : U \rightarrow \mathbf{R}^n$ be the bifurcation problem referred to above. Then there is an open neighborhood U' of 0 with $U' \subset U$ such that, on U' , G and $\det d_x G$ vanish simultaneously only at 0.*

Note. We may assume that $U' = S \times L$, where S and L are open neighborhoods of 0 in \mathbf{R}^n and \mathbf{R} , respectively.

Proof: Let $Q : (\mathbf{R}^n \times \mathbf{R}, 0) \rightarrow (\mathbf{R}^n \times \mathbf{R}, 0)$ be defined by $Q(x, \lambda) = (G, \det d_x G)$. The lemma is equivalent to stating that Q has an isolated zero at $(x, \lambda) = 0$. Since the germ G has finite codimension we may assume by Corollary 2.9 that G is a polynomial mapping, hence so is Q . By a standard theorem in algebraic geometry (cf. [11]), Q has an isolated zero if $\mathcal{E}_{x,\lambda} \langle G_1, \dots, G_n, \det d_x G \rangle$ has finite dimension. Let A be the ring $\mathcal{E}_{x,\lambda} \langle G \rangle$.

Claim. $\dim A / \{\det d_x G\}A < \infty$ if $\dim A^n / \{\partial G / \partial x_1, \dots, \partial G / \partial x_n\}A < \infty$. Using the remarks above this claim proves the lemma since $A^n / \{\partial G / \partial x_1, \dots, \partial G / \partial x_n\}A \cong \mathcal{E}_{x,\lambda}^n / \tilde{T}G$. To prove the claim let $K = \{a \in A \mid a \cdot A^n \subset \{\partial G / \partial x_1, \dots, \partial G / \partial x_n\}A\}$ and $(K)^n = \{a \in A \mid a = a_1 \cdots a_n \text{ where each } a_i \text{ is in } K\}$. The assumption that G has finite codimension implies that $\mathcal{M}^k \mathcal{E}_{x,\lambda}^m \subset \tilde{T}G$ for some k . So $\mathcal{M}^k \subset K$ and $\mathcal{M}^{nk} \subset (K)^n$. Hence $\dim A / (K)^n < \infty$. Now suppose $a_1, \dots, a_n \in K$. Then $a_i \partial G / \partial x_i = \sum_{j=1}^n r_{ij} \partial G / \partial x_j$ for r_{ij} in A . In matrix form these equations state that

$$\begin{pmatrix} a_1 & \cdots & a_n \\ 0 & \cdots & 0 \end{pmatrix} = (r_{ij})(d_x G)$$

as A -linear mappings on A^n . Computing determinants yields $a_1 \cdots a_n = \det(r_{ij}) \det(d_x G)$ in A . Hence $(K)^n \subset \{\det(d_x G)\}A$ and $\dim A / \{\det d_x G\}A \cong \dim A / (K)^n < \infty$.

LEMMA 3.13. *Let $G(x, \lambda)$ be a bifurcation problem. Suppose that $\text{rank}(d_x G)(0) = k$. Then G is contact equivalent to*

$$\bar{G}(\bar{x}_1, \dots, \bar{x}_n, \lambda) = (\bar{x}_1, \dots, \bar{x}_k, \bar{g}_{k+1}(y, \lambda), \dots, \bar{g}_n(y, \lambda)),$$

where $y = (\bar{x}_{k+1}, \dots, \bar{x}_n)$.

Proof: By linear changes of coordinates of \mathbf{R}^m and \mathbf{R}^n we may assume that

$$(d_x G)(0) = \begin{pmatrix} I_k & 0 \\ 0 & 0 \end{pmatrix}.$$

Writing $G = (g_1, \dots, g_m)$ in these coordinates, we may set $\bar{x}_1 = g_1, \dots, \bar{x}_k = g_k$ and choose $\bar{x}_{k+1}, \dots, \bar{x}_n$ to give a coordinate system on \mathbf{R}^n . Next write G in these coordinates as

$$G(\bar{x}_1, \dots, \bar{x}_n, \lambda) = (\bar{x}_1, \dots, \bar{x}_k, g_{k+1}(\bar{x}, \lambda), \dots, g_n(\bar{x}, \lambda)).$$

Expand g_i for $k+1 \leq i \leq n$ by Taylor's theorem to get

$$g_i(\bar{x}, \lambda) = \bar{g}_i(\bar{y}, \lambda) + \sum_{j=1}^k \bar{x}_j h_{ij}(\bar{x}, \lambda).$$

Let

$$\tau_{\bar{x}, \lambda} = \begin{pmatrix} I_k & 0 \\ -h_{ij} & I_{m-k} \end{pmatrix}.$$

For each (\bar{x}, λ) , $\tau_{\bar{x}, \lambda}$ is invertible and $\bar{G} = \tau_{\bar{x}, \lambda} G$ is the desired function.

Next we give a normal form for limit points.

LEMMA 3.14. *Let $G : (\mathbf{R}^n \times \mathbf{R}, 0) \rightarrow (\mathbf{R}^n, 0)$ have a limit point at 0. Then G is contact equivalent to $H(x_1, \dots, x_n, \lambda) = (\lambda \pm x_1^2, x_2, \dots, x_n)$.*

Proof: Recall from the discussion after Figure 2.1 that a limit point means that $\text{rank}(dG)(0) = n$ and that G has a vertical tangent at 0. Thus $\text{rank}(d_x G)(0) = n-1$. By Lemma 3.13, G is contact equivalent to $\bar{G}(x, \lambda) = (g_1(x_1, \lambda), x_2, \dots, x_n)$ with $g_1(0) = 0$ and $\partial g_1(0)/\partial x_1 \neq 0$. The condition that G be a limit point also implies that $\partial^2 g_1(0)/\partial x_1^2 \neq 0$. It is now easy to show that $g_1(x_1, \lambda) = \tau(x_1, \lambda)(\lambda - h(x_1))$, where $\tau(0) \neq 0$, $\partial h(0)/\partial x_1 = 0$ and $\partial^2 h(0)/\partial x_1^2 \neq 0$. A simple contact equivalence gives the desired result.

Note. This normal form shows that

- (i) limit points are isolated;
- (ii) limit points are stable, i.e., a small perturbation of G will yield an isolated limit point near 0.

Proof of Theorem 2.15: By Lemma 3.12 there exists an open neighborhood U' of 0 with \bar{U}' compact and contained in U such that G and $\det d_x G$ vanish simultaneously in U' only at 0. Let Z be a neighborhood of 0 with $\bar{Z} \subset U'$. By continuity there exists a neighborhood V' of 0 in V such that F and $\det d_x F$ do not vanish simultaneously on $(\bar{U}' \sim Z) \times V'$. (To see this consider the function $\|F\| + |\det d_x F|$ which is bounded away from 0 on $(\bar{U}' \sim Z) \times \{0\}$.) Now assume U' has the form $S \times L$, where $S \subset \mathbf{R}^n$ and $L \subset \mathbf{R}$ are open neighborhoods of 0 as noted after Lemma 3.12.

Suppose α is in $V' \sim C$. Then the bifurcation diagram associated to F_α on V' is a collection of non-singular, non-intersecting curves with only limit points as vertical tangents. Also the λ values of the limit points are distinct. Let $\lambda_1, \dots, \lambda_s$ be the distinct λ values of the limit points for F_α . Choose disjoint open neighborhoods L_i of λ_i in L and a neighborhood N of α such that for all β in N :

- (a) F_β is non-singular on U' ,
- (b) F_β has only limit points as vertical tangents,
- (c) F_β has no limit points with λ values in $L \sim \bigcup_{i=1}^s L_i$,
- (d) F_β has precisely one limit point with λ value $\lambda_i(\beta)$ in L_i .

This is possible by Lemma 3.14 and the subsequent notes. (So $V' \sim C$ is an open set.) We now show that, for every β in N , F_β is contact equivalent to F_α . First note that a change of coordinates on L will take $\lambda_i(\beta)$ to λ_i . Hence we may assume that the λ values of the limit points are the same for F_β and F_α . Next by a linear change of coordinates ρ_λ on \mathbf{R}^n we can assume that the actual limit points of F_β and F_α occur at the same points. (This follows since the limit points in $S \times \{\lambda_i\}$ for F_β and F_α are unique.) Now apply Lemma 3.14 to obtain neighborhoods L'_i of λ_i on which $F_\beta = F_\alpha$. (The normal form implies that the functions defining any two limit points are contact equivalent.) Next observe that, on $L \sim \bigcup_{i=1}^s L'_i$, the curves in the diagrams associated to F_α and F_β are all parametrized by λ since $d_x F_\alpha$ and $d_x F_\beta$ are non-singular. It is easy to see that F_α and F_β are now contact equivalent by applying a diffeomorphism $\rho_\lambda : S \rightarrow S$.

4. Computations with One Degree of Freedom

In this section we analyze perturbed bifurcation diagrams when there is one state variable present ($n = 1$) and one equation ($m = 1$). As mentioned in Section 1 these results are equally valid for both conservative as well as non-conservative systems. Now given a finite codimension bifurcation problem $G(x, \lambda)$ we may assume without loss of generality that $G(x, 0) = x^m + \text{higher-order terms}$ for some m . Hence by a change of coordinates in x , $G(x, 0) = x^m$. In our exposition we shall consider the following cases:

- (I)_m $x^m \pm \lambda$, $m \geq 2$,
- (II)_m $x^m \pm \lambda x$, $m \geq 2$,
- (III) $x^3 \pm \lambda^2 x$,
- (IV) $x^2 h(x, \lambda)$.

Note. The bifurcation problem (II)₂ is contact equivalent to $x^2 - \lambda^2$. This equivalence is obtained by letting $\rho_\lambda(x) = x - \lambda$ and $\Lambda(\lambda) = \pm 2\lambda$.

The first two problems are obtained under the following conditions:

PROPOSITION 4.1. *Let $H(x, \lambda)$ be a bifurcation problem satisfying $H(x, 0) = x^m + \dots$. Then H is contact equivalent to*

- (I)_m *if and only if $\partial H(0)/\partial \lambda \neq 0$,*

or to

- (II)_m *if and only if $\partial H(0)/\partial \lambda = 0$, rank $(d^2 H)(0) = 2$, and index $(d^2 H)(0) = 1$.*

Note. When $m \geq 3$, the conditions on rank and index are equivalent to $\partial^2 H(0)/\partial x \partial \lambda \neq 0$, whereas, when $m = 2$, $x^2 - \lambda^2$ satisfies the conditions of the proposition.

When $m = 2$ and index $(d^2 H)(0) \neq 1$, one obtains the problem $x^2 + \lambda^2$. Such problems appear in the chemical engineering literature under the name of *isolas* (cf. [21]).

Proof: Whether or not $(dH)(0)$ is zero is an invariant of contact equivalence. So the conditions defining $(I)_m$ are necessary. If $(dH)(0) = 0$, then the bilinear form $(d^2 H)(0)$ is an invariant of contact equivalence. Thus the conditions defining $(II)_m$ are also necessary.

The sufficiency of $(II)_m$ for $m \geq 3$ is given by Lemma 2.7. The conditions on $(II)_2$ allow one to normalize the Hessian matrix by a linear contact equivalence to obtain $x^2 - \lambda x + \text{higher-order terms}$. One can now apply Lemma 2.7 in this situation as well. For the sufficiency of $(I)_m$ note that changes of coordinates in x alone and λ alone will put H in the form $G + P$, where $G(x, \lambda) = x^m \pm \lambda$ and $P = \lambda^2 P_1 + x \lambda P_2$. Now $\tilde{T}G = \langle x^m \pm \lambda, m x^{m-1} \rangle = \langle \lambda, x^{m-1} \rangle$. Hence P is in $\mathcal{M}\tilde{T}G$ and so $P = aG + b(\partial G/\partial x)$, where $a(0) = b(0) = 0$. Next note that $\partial P/\partial x = \lambda Q$ for some Q . Thus we may write $\partial P/\partial x = cG + e(\partial G/\partial x)$, where $e(0) = 0$. Now apply the note after Proposition 3.11. Since $t \begin{pmatrix} a & b \\ c & e \end{pmatrix} - I_2$ is invertible at 0, $G + P$ is contact equivalent to G .

PROPOSITION 4.2. *A universal unfolding with the minimum number of parameters for*

- | | | |
|-------------------|----|---|
| (I) _m | is | $F_\alpha(x, \lambda) = x^m + \alpha_{m-2}x^{m-2} + \cdots + \alpha_1 x \pm \lambda,$ |
| (II) _m | is | (a) $F_\alpha(x, \lambda) = x^m + \alpha_{m-1}x^{m-1} + \cdots + \alpha_2 x^2 \pm \lambda x + \alpha_1,$ |
| | or | (b) $F_\alpha(x, \lambda) = x^m + \alpha_{m-2}x^{m-2} + \cdots + \alpha_2 x^2 \pm \lambda x + \alpha_1 + \alpha_{m-1} \lambda,$ |
| (III) | is | $F_\alpha(x, \lambda) = x^3 \pm \lambda^2 x + (\alpha_1 + \alpha_2 x + \alpha_3 x^2) + (\alpha_4 + \alpha_5 x^2) \lambda.$ |

The number of parameters are $m-2$, $m-1$ and 5, respectively.

(IV) has infinite codimension.

Note. One can generalize (III) to show that $x^3 - \lambda^k x$ has codimension $3k-1$.

Proof: (I) Let $G(x, \lambda) = x^m \pm \lambda$. Then $\tilde{T}G = \langle \lambda, x^{m-1} \rangle$. Since $\partial G/\partial \lambda = \pm 1, x, x^2, \dots, x^{m-2}$ project onto a basis of \mathcal{E}_2/TG . Apply Theorem 2.4 and the subsequent discussion.

(II) Let $G(x, \lambda) = x^m \pm \lambda x$. Then $\tilde{T}G = \langle x^m, \lambda - m x^{m-1} \rangle$. Since $\partial G/\partial \lambda = \pm x$ and $\lambda x \in \tilde{T}G$, $1, x^2, \dots, x^{m-1}$ projects onto a basis of \mathcal{E}_2/TG . Notice that $1, \lambda, x^2, \dots, x^{m-2}$ also projects onto a basis. Applying Theorem 2.4 to these bases gives the desired normal forms.

(III) Let $G(x, \lambda) = x^3 \pm \lambda^2 x$. Then $\tilde{T}G = \langle x^3, 3x^2 \pm \lambda^2 \rangle$. Note that λ^4 is in $\tilde{T}G$. We use Taylor's theorem to compute the codimension of $\tilde{T}G$. Let $f(x, \lambda)$

be in \mathcal{E}_2 , then

$$f = a_0(x) + a_1(x)\lambda + a_2(x)\lambda^2 + a_3(x)\lambda^3 \pmod{\tilde{T}G}.$$

Exchanging λ^2 for $3x^2$, we have $f(x, y) = b_0(x) + b_1(x)\lambda \pmod{\tilde{T}G}$. Eliminating multiples of x^3 one obtains

$$f(x, y) = \alpha_0 + \alpha_1 x + \alpha_2 x^2 + (\beta_0 + \beta_1 x + \beta_2 x^2)\lambda \pmod{\tilde{T}G}.$$

Finally note that $\partial G/\partial \lambda = \pm 2\lambda x$ so that modulo TG the coefficient β_1 may be eliminated. We have thus shown that $1, x, x^2, \lambda, x^2\lambda$ form a spanning set for \mathcal{E}_2/TG . We leave it to the reader to show that this set is actually a basis. Applying Theorem 2.4 gives the desired universal unfolding.

(IV) $\tilde{T}G = \langle x^2 h(x, \lambda), x[2h + x\partial h/\partial x] \rangle$. Hence $\lambda, \lambda^2, \lambda^3, \dots$ are independent in $\mathcal{E}_2/\tilde{T}G$.

The example $(II)_3$ occurs in many different contexts. It is thus useful to be able to determine when a 2-parameter unfolding $F_{\alpha, \beta}$ of G is contact equivalent to the normal form for $(II)_3$. For the following lemma we write $F(x, \lambda, \alpha, \beta)$ for $F_{\alpha, \beta}(x, \lambda)$, reserving subscripts to denote partial differentiation, and put a bar above a function to indicate evaluation at 0. For example, $\bar{F}_x = \partial F(0, 0, 0, 0)/\partial x$. Clearly we must assume that G is contact equivalent to $x^3 - \lambda x$. In view of Proposition 4.1 we assume that $\bar{G} = \bar{G}_x = \bar{G}_\lambda = \bar{G}_{xx} = 0$, and that $\bar{G}_{xxx}\bar{G}_{x\lambda} < 0$. (If $\bar{G}_{xxx}\bar{G}_{x\lambda} > 0$, we have subcritical bifurcation.) Let $j(L)$ be the vector $(\bar{L}, \bar{L}_x, \bar{L}_{xx}, \bar{L}_\lambda)$ viewed as a column vector and let $J(F) = \det(j(F_x), j(F_\lambda), j(F_\alpha), j(F_\beta))$.

LEMMA 4.3. F is a universal unfolding for G if and only if $J(F) \neq 0$.

Proof: Suppose that $L(x, \lambda, \alpha, \beta) = T(x, \lambda) \cdot F(X(x, \lambda), \Lambda(\lambda), \alpha, \beta)$; then a tedious but straight-forward calculation shows that $J(L) = \bar{T}^4 \bar{\Lambda}^2 \bar{X}_x^4 J(F)$. Since G is contact equivalent to $x^3 - \lambda x$, there exists T, X and Λ with $\bar{T} \neq 0, \bar{X}_x \neq 0$ and $\bar{\Lambda} \neq 0$ such that

$$T \cdot F(X, \Lambda) = x^3 - \lambda x + \alpha a(x, \lambda, \alpha, \beta) + \beta b(x, \lambda, \alpha, \beta).$$

Hence $J(F) = -\bar{b}(\bar{a}_{xx} + 6\bar{a}_\lambda) + \bar{a}(\bar{b}_{xx} + 6\bar{b}_\lambda)$. By Theorem 2.4, F is a universal unfolding of $x^3 - \lambda x$ if and only if $a(x, \lambda, 0, 0)$ and $b(x, \lambda, 0, 0)$ project onto a basis in $N = \mathcal{E}_{x, \lambda}/[(x^3 - \lambda x, 3x^2 - \lambda) + \mathbf{R}\{x\}]$. Now $a = \bar{a} + (\frac{1}{2}\bar{a}_{xx} + 3\bar{a}_\lambda)x^2$ and $b = \bar{b} + (\frac{1}{2}\bar{b}_{xx} + 3\bar{b}_\lambda)x^2$ in N . We proved in Example 2.6 that 1 and x^2 project

onto a basis in N . Consequently, F is a universal unfolding if

$$\det \begin{pmatrix} \bar{a} & \frac{1}{2}\bar{a}_{xx} + 3\bar{a}_\lambda \\ \bar{b} & \frac{1}{2}\bar{b}_{xx} + 3\bar{b}_\lambda \end{pmatrix} = \frac{1}{4}J(F) \neq 0.$$

We shall use this lemma in Section 6.

EXAMPLE. Consider $F(x, \lambda, \alpha, \beta) = x - \alpha - (2\lambda + 1) \sin x + \beta \cos x$ as an unfolding of $G(x, \lambda) = x - (2\lambda + 1) \sin x$. This is the actual bifurcation problem obtained from the finite-element analogue to the Euler beam problem considered in the introduction. It is easy to check that the conditions on G listed above are satisfied and that $J(F) = 4 \neq 0$. This reconfirms our statement that F is a universal unfolding of G contact equivalent to $x^3 + \alpha x^2 - \lambda x + \beta$.

We now analyze the bifurcation diagrams associated with the examples $(I)_m$, where $G(x, \lambda) = x^m - \lambda$. The reader may wish to review the discussion in Section 2 concerning stability of diagrams; in particular, (2.10), (2.12) and (2.13) and Corollary 2.16. Proposition 4.2 states that a universal unfolding for $(I)_m$ is $F_\alpha(x, \lambda) = x^m + \alpha_{m-2}x^{m-2} + \dots + \alpha_1x - \lambda$. Since $\partial F_\alpha / \partial \lambda = -1 \neq 0$, there are no type B control points; i.e., no traditional bifurcation points. The bifurcation diagram $D(F_\alpha)$ is given by $\lambda = \lambda_\alpha(x) = x^m + \alpha_{m-2}x^{m-2} + \dots + \alpha_1x$. Vertical tangents correspond to critical points of λ_α . Hence type H control points (hysteresis points) correspond to degenerate critical points for λ_α . This is just the standard bifurcation surface from elementary catastrophe theory (cf. [10]). In that language the type DL control points (double limit points) correspond to the Maxwell set of critical points with equal critical values.

m = 2: G is a limit point and is thus stable by Lemma 3.14.

m = 3: $F_\alpha(x) = x^3 - \lambda + \alpha x$ is the universal unfolding. The universal imperfections diagram is a line, Figure 4.1. The associated diagrams are given in Figure 4.2. We suggest the term *non-degenerate hysteresis point* for this bifurcation problem and give an example of its occurrence in Section 7.

m = 4: $F_{\alpha,\beta}(x, \lambda) = x^4 + \alpha x^2 + \beta x - \lambda$ is the universal unfolding. The universal imperfections diagram is given in Figure 4.3. The control set is a cusp (type H points) and a ray (type DL points or Maxwell set). The corresponding diagrams are shown in Figure 4.4.

m = 5: $F_{p,q,r}(x, \lambda) = x^5 - px^3 + qx^2 + rx - \lambda$. The type H points form the swallow's tail shown in Figure 4.5. The diagrams in region 1 have no limit points. In region 2 these are two limit points and in region 3 there are four limit points. The diagrams in each of regions 1 and 2 are equivalent. There are type DL points in region 3 which are somewhat difficult to identify. On



Figure 4.1. Universal imperfections diagram, for $m = 3 : F_\alpha(x) = x^3 - \lambda + \alpha x$.

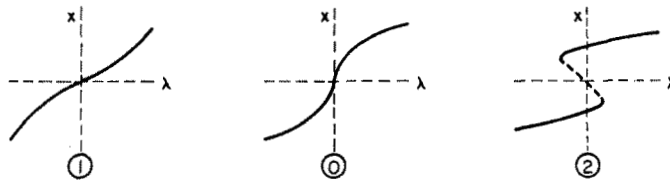

Figure 4.2. Associated diagrams of Figure 4.1.

the other hand, the actual stable diagrams are easy to find. Let $(x_i, \lambda_i), i = 1, \dots, 4$, be the four limit points of a diagram in region 3. Without loss of generality assume that $x_1 < x_2 < x_3 < x_4$. Note that there are some restrictions on the ordering of the λ_i . (Since a stable point is not a control point we assume that the λ_i are distinct.) The restrictions are:

- (i) $\lambda_1 > \lambda_2$,
- (ii) $\lambda_2 < \lambda_3$,
- (iii) $\lambda_3 > \lambda_4$.

There are five possibilities;

- (3A) $\lambda_2 < \lambda_1 < \lambda_4 < \lambda_3$,
- (3B) $\lambda_2 < \lambda_4 < \lambda_1 < \lambda_3$,
- (3C) $\lambda_2 < \lambda_4 < \lambda_3 < \lambda_1$,
- (3D) $\lambda_4 < \lambda_2 < \lambda_1 < \lambda_3$,
- (3E) $\lambda_4 < \lambda_2 < \lambda_3 < \lambda_1$.

The associated diagrams are given in Figure 4.6.

One can now see a method for determining the stable diagrams near a type (I) bifurcation problem. Determine the possible number of limit points and the possible orderings of the λ values of the limit points. Each such

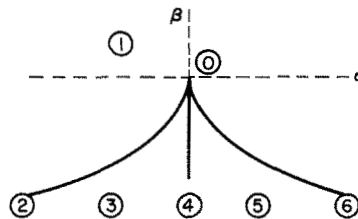

Figure 4.3. Universal imperfections diagram for $m = 4 : F_{\alpha, \beta}(x, \lambda) = x^4 + \alpha x^2 + \beta x - \lambda$.

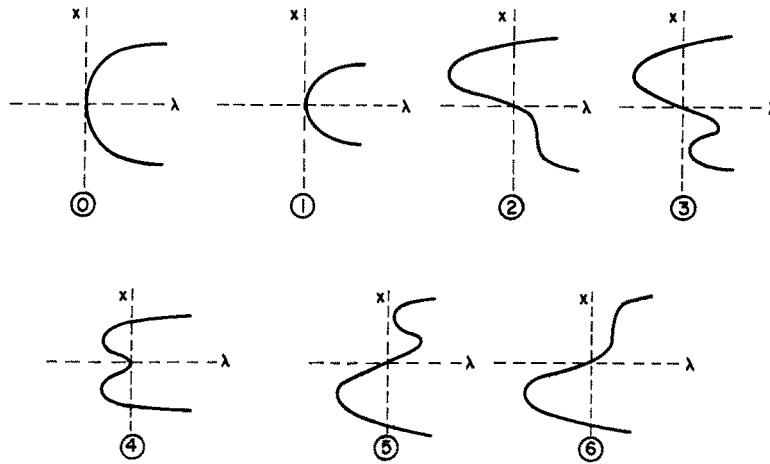

Figure 4.4. Associated diagrams of Figure 4.3.

allowable configuration will occur, thus yielding the desired classification.

We now analyze the case $(II)_m$ examples for small m .

$m = 2$: $F_\alpha(x, \lambda) = x^2 - \lambda x + \alpha$. The universal imperfections diagram is a line, Figure 4.1. There is one type B point (the origin) and no type H or DL points. The associated diagrams are given in Figure 4.7.

Note. The similar problem $x^2 + \lambda^2$ also has codimension one, a universal unfolding being $x^2 + \lambda^2 + \alpha$. The associated diagrams are empty for $\alpha > 0$ and circles for $\alpha < 0$.

$m = 3$: $F_{p,q}(x, \lambda) = x^3 + qx^2 - \lambda x + p$. This case was analyzed in the introduction. At this point it may be instructive to show how this example relates to the catastrophe theory cusp. For this purpose it is easier to use the

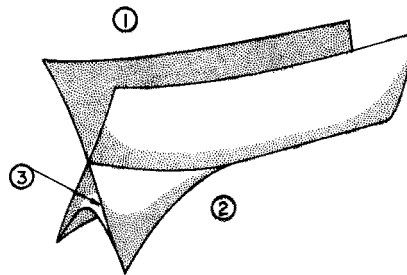

Figure 4.5. Swallow's tail.

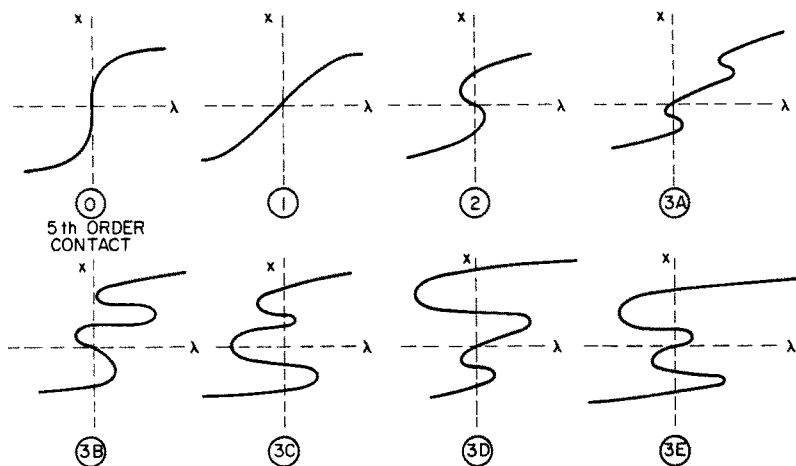
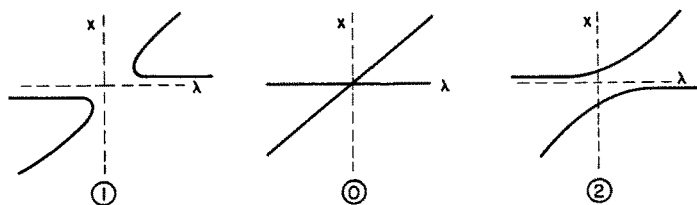

Figure 4.6. Associated diagrams for Figure 4.5.

alternate unfolding listed for $(II)_3$ in Proposition 4.2; namely, $F_{p,q}(x, \lambda) = x^3 - \lambda x + p + q\lambda$. Now consider the surface $S = \{x^3 - \beta x + \alpha = 0\}$ given in Figure 4.8. Let π be the projection of S into α, β -space. The cusp curve is just the set of critical values of π . Next write $F_{p,q}(x, \lambda) = x^3 - \beta_{p,q}(\lambda)x + \alpha_{p,q}(\lambda)$, where $(\beta(\lambda), \alpha(\lambda)) = (\lambda, p + q\lambda)$. Thus we have equated the unfolding F with lines (parametrized by λ) in α, β -space. Given such a line one finds the associated bifurcation diagram by intersecting S with the plane which includes the line and is perpendicular to the α, β -plane. For example, if one lets $p = q = 0$, then the line is the β -axis and the intersection is the pitchfork. The lines pictured in Figure 4.9 yield the diagrams associated with the open regions in Figure 1.4.

We have found considerations such as this extremely useful in interpreting and guessing results about the perturbed bifurcation diagrams. We shall use this technique when analyzing examples (III) and (IV). The formalization of

Figure 4.7. Diagrams associated to $F_\alpha(x, \lambda) = x^2 - \lambda x + \alpha$.

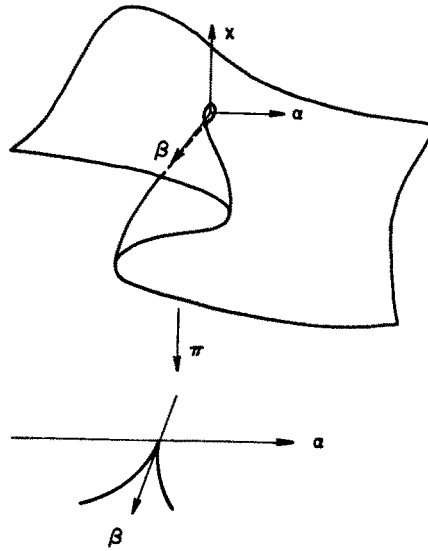

Figure 4.8. Illustration of the surface $S = \{x^3 - \beta x + \alpha = 0\}$.

this method yields one description for imperfect bifurcation in the conservative case. We shall discuss this approach in more detail in Section 8.

m = 4: $F_{p,q,r}(x, \lambda) = x^4 - \lambda x - px^2 + q + r\lambda$. A simple calculation shows that the type B points satisfy the equation

$$(4.4) \quad q = pr^2 - r^4.$$

The type H points satisfy the equation

$$(4.5) \quad (q + \frac{1}{12}p^2)^2 = \frac{8}{27}p^3r^2 \quad \text{for } p \geq 0.$$

The computation for type DL points is slightly more delicate. We must

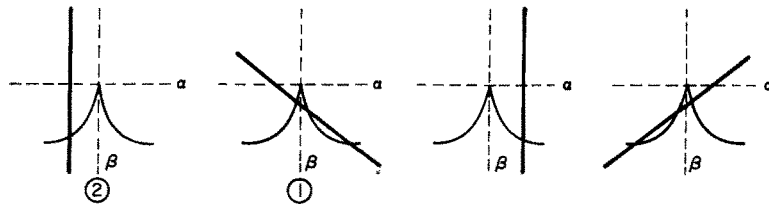

Figure 4.9. Lines which generate the diagrams associated to Figure 1.4.

determine for which p, q, r there exist x, y and λ with $x \neq y$ satisfying:

$$(4.6) \quad x^4 - px^2 - \lambda x + q + r\lambda = 0,$$

$$(4.7) \quad y^4 - py^2 - \lambda y + q + r\lambda = 0,$$

$$(4.8) \quad 4x^3 - 2px - \lambda = 0,$$

$$(4.9) \quad 4y^3 - 2py - \lambda = 0.$$

Subtracting (4.9) from (4.8) and dividing by $x - y$ yields

$$(4.10) \quad p = 2(x^2 + xy + y^2).$$

Subtracting (4.7) from (4.6), dividing by $x - y$, and substituting (4.10) yields

$$(4.11) \quad \lambda = -(x + y)^3.$$

Now substitute (4.10) and (4.11) in (4.8) and divide by $(x - y)^2$ to obtain

$$(4.12) \quad y = -x.$$

Thus $\lambda = 0$ by (4.11) and one sees that type DL points satisfy

$$(4.13) \quad q = \frac{1}{4}p^2 \text{ for } p > 0.$$

To find the universal imperfections diagram, we graph (4.4), (4.5) and (4.13) for $p > 0$, $p = 0$ and $p < 0$. For $p < 0$ and $p = 0$ this is easy. The resulting diagrams are shown in Figure 4.10. For $p > 0$ we can scale p out of

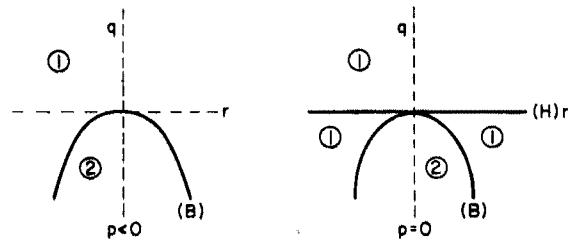

Figure 4.10. Graph of (4.4), (4.5) and (4.13) for $p < 0$ and $p = 0$.

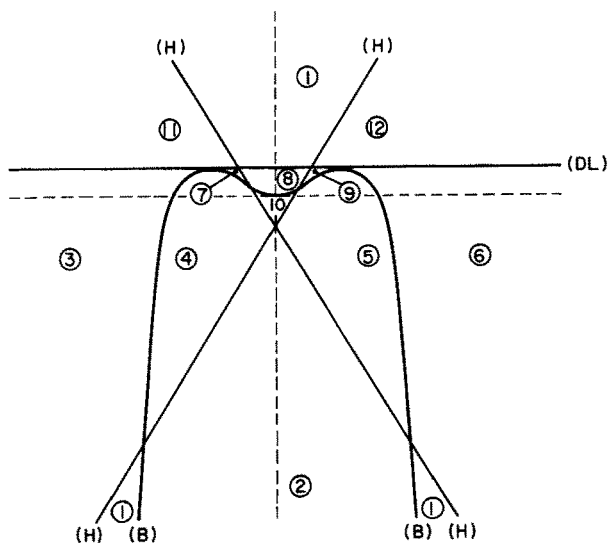

Figure 4.11. Graph of (4.4), (4.5) and (4.13) for $p > 0$.

the problem by letting $p^2\bar{q} = q$ and $\sqrt{p}\bar{r} = r$ to obtain

$$(4.4') \quad \bar{q} = \bar{r}^2 - \bar{r}^4,$$

$$(4.5') \quad \bar{q} = -\frac{1}{12} \pm (\sqrt{3}/27)\bar{r},$$

$$(4.13') \quad \bar{q} = \frac{1}{4}.$$

The imperfections diagram is shown in Figure 4.11 and the diagrams associated with each region are given in Figure 4.12.

Using example (III) we shall be able to add a new complication to our description of bifurcation diagrams. Corollary 2.16 shows that in each component of the complement to the control set the associated bifurcation diagrams are stable in the technical sense that they all lead to contact equivalent bifurcation problems. We have also shown by Corollary 2.9 that we may assume that the control set is an algebraic variety. A reasonable question then is whether the bifurcation problems associated with each component (in the algebraic sense) of the control set are contact equivalent. This statement is true for the previous example but as we shall now see is false in general. To see this we shall use the cross-ratio.

Recall that, given four intersecting lines in the plane with slopes

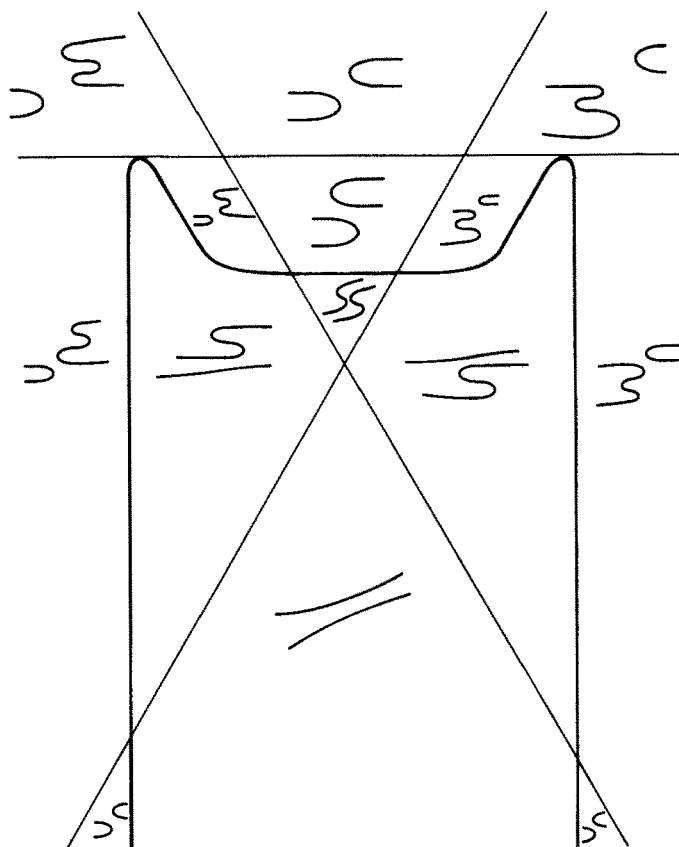

Figure 4.12. Diagrams associated with each region given in Figure 4.11.

m_1, \dots, m_4 , the cross-ratio is defined by

$$\text{CR} = \frac{(m_1 - m_3)(m_2 - m_4)}{(m_1 - m_2)(m_3 - m_4)}.$$

Also note that if $m_1 = 0$ and $m_4 = \infty$, then $\text{CR} = m_3/m_2$. The salient feature of CR is: Given two sets of four intersecting lines in the plane and a linear mapping which maps one set of lines onto the second, then the cross-ratios of these two sets of lines are equal.

We now return to (III), which is $G(x, \lambda) = x^3 - \lambda^2 x$. The diagram $G = 0$ is easily seen to be three lines crossing at the origin. Included in the universal unfolding of G is one parameter which preserves this property. Let

$H_\beta(x, \lambda) = x^3 - \lambda^2 x - 2\beta x^2 \lambda$. The diagram $H_\beta = 0$ consists of three lines with slopes 0 and $\beta \pm (\beta^2 + 1)^{1/2}$. Now suppose that H_β is contact equivalent to G . Then there would be a diffeomorphism $\sigma(x, \lambda) = (\rho(x, \lambda), \Lambda(\lambda))$ mapping $\{H_\beta = 0\}$ onto $\{G = 0\}$. Since these sets consist of lines, the same would be true for the Jacobean matrix $(d\sigma)(0)$. Moreover the form of σ dictates that the line $\{\lambda = 0\}$ is also preserved by $(d\sigma)_0$. Thus the linear mapping $(d\sigma)_0$ maps four lines onto four other lines and the cross-ratio must be preserved. The slopes for the lines associated with H_β are $0, \infty, \beta \pm (\beta^2 + 1)^{1/2}$. Hence $CR = -(\beta + (\beta^2 + 1)^{1/2})^2$. These numbers are all different for β near 0; thus we have proved the following:

PROPOSITION 4.14. *The unfolding H_β is a one-parameter family of contact inequivalent bifurcation problems.*

This is the first example of *moduli* in the bifurcation diagrams; we shall give another in Section 5. Although we have no physical interpretation of the moduli we should point out that this bifurcation problem does occur in physical situations; see Section 7. Also the existence of moduli makes Theorem 2.15 even more important since we know that the stable diagrams are finite in number.

The moduli parameter seems to serve another role. One feels that the codimension of a bifurcation problem (that is, the number of unfolding parameters) should measure the number of defining conditions minus the number of degrees of freedom. For example $G(x, \lambda) = x^3 - \lambda x$ is defined by the four conditions $G = \partial G / \partial \lambda = \partial G / \partial x = \partial^2 G / \partial x^2 = 0$ at the origin along with some non-degeneracy conditions on higher derivatives. Since the number of degrees of freedom for G is two (one each for x and λ) we have the precise relationship $\text{codim } G = 4 - 2$. This relationship is also valid for the previous examples of this section. However, for the present example $G(x, \lambda) = x^3 - \lambda^2 x$, $\text{codim } G = 5$ while the number of defining conditions is 6 since G must vanish through order 2 in x and λ at the origin. The seeming excess of codimension ($5 > 4$) is accounted for by the moduli parameter. Let the *modality* of G be the number of moduli parameters in the universal unfolding of G . The following relation seems to hold though we have no proof: $\text{codim } G = \text{number of defining conditions minus } n \text{ plus modality}$.

This relationship is obtained for some examples of bifurcation when $m = n = 2$ in Section 5. The next discussion shows that even on the diagram level all the unfolding parameters for $G(x, \lambda) = x^3 - \lambda^2 x$ are necessary.

To analyze the stable diagrams near $x^3 - \lambda^2 x = 0$, we return to the cusp picture Figure 4.8 used in analysing $(II)_3$. The universal unfolding that is convenient is

$$F_{p,q}(x) = x^3 - \lambda x + (p + \lambda^2)x + (q_0 + q_1\lambda + q_2\lambda^2 + q_3\lambda^3).$$

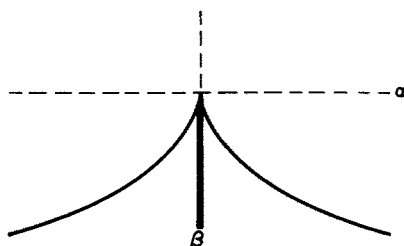
Figure 4.13. Path associated to $x^3 - \lambda^2 x = 0$.

Consequently, $\alpha(\lambda) = q_0 + q_1\lambda + q_2\lambda^2 + q_3\lambda^3$ and $\beta(\lambda) = p + \lambda^2$ in the equation $x^3 - \beta x + \alpha = 0$. For $p = q = 0$ this curve is just a double covering of the ray splitting the cusp $\frac{1}{4}\alpha^2 = \frac{1}{27}\beta^3$ shown in Figure 4.13. The stable diagrams are associated with the curves $\gamma(\lambda) = (\alpha(\lambda), \beta(\lambda))$ which are nowhere tangent to the cusp. Since $\alpha(\lambda)$ is cubic in λ and $\beta(\lambda)$ is quadratic, the maximum number of intersections of γ with the cusp is six. Since we analyze only small perturbations, we may assume that q_i is near 0; hence $\gamma(\lambda)$ for $|\lambda|$ large is inside the cusp and the number of intersections is even. Next observe that the qualitative nature of the bifurcation diagram associated with γ is determined by the number of intersections and whether the intersections occur on the left or right nappes of the cusp. For example, the paths *LLRR*, *LRRRL* and *RLLRR* are shown in Figure 4.14 along with the associated bifurcation diagrams. Here *L* and *R* stand for an intersection of γ with the left and right nappes, respectively. The degrees of $\alpha(\lambda)$ and $\beta(\lambda)$ imply that the curve γ has at most one horizontal and two vertical tangents. Thus sequences like *LRRL* are not possible. If one enumerates all the possibilities subject to the above constraints one finds at most 53 possible distinct stable diagrams.

We now consider our last example of this section, case (IV). As was shown in Proposition 4.2 the problem $G(x, \lambda) = x^2 h(x, \lambda)$ has infinite codimension. For this example (and we suspect in general) there is a good reason why this problem has infinite codimension.

PROPOSITION 4.15. *The bifurcation diagram associated with the bifurcation problem $G(x, \lambda) = x^2 h(x, \lambda)$ can be perturbed by arbitrarily small perturbations into an infinite number of inequivalent bifurcation diagrams.*

Proof: Let $\phi(\lambda)$ be a smooth germ and let $G_\phi(x, \lambda) = (x^2 - \phi(\lambda))h(x, \lambda)$. The bifurcation diagram of G consists of two sets $h = 0$ and $x = 0$, while the bifurcation diagram of G_ϕ consists of the two sets $h = 0$ and $x^2 = \phi(\lambda)$. Thus if the graph of ϕ has the form indicated in Figure 4.15, then the perturbed diagrams will include Figure 4.16. By choosing ϕ appropriately (and small) we can create as many circles as desired.

It seems to us that this example provides a good test of our theory. Here

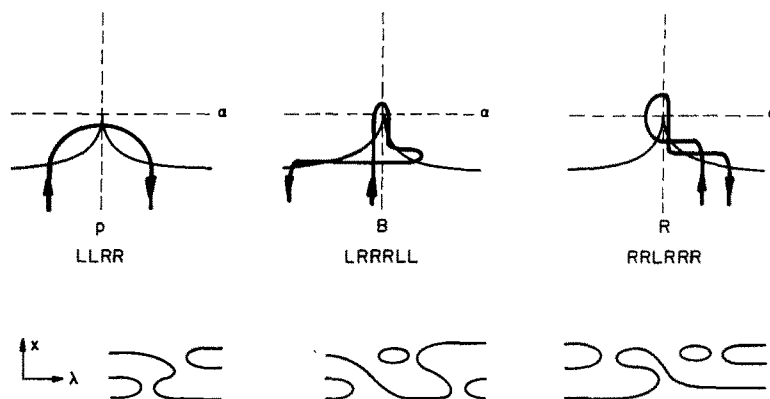

Figure 4.14. Paths *LLRR*, *LRRLL* and *RRLRRR* together with their associated bifurcation diagrams.

infinite codimension of the bifurcation problem indicates a diagram that disintegrates in an infinite number of different ways. Geometrically one can see why this is true. Let $h(x, \lambda) = x - 3\lambda$. Then G is equivalent via the coordinate change $\rho_\lambda(x) = x + \lambda$ to $x^3 - 3\lambda^2x - 2\lambda^3$. The curve $(\alpha(\lambda), \beta(\lambda))$ is the cusp curve itself in the α, β -plane. It is clear geometrically that small perturbations of this curve can change the associated diagram in an infinity of different ways.

5. Computations at a Double Eigenvalue

For most of this section we shall concentrate on bifurcation problems $G : (\mathbf{R}^2 \times \mathbf{R}, 0) \rightarrow (\mathbf{R}^2, 0)$ of the form

$$(5.1) \quad G(z, \lambda) = Q(z) - \lambda z,$$

where $z = (x, y) \in \mathbf{R}^2$, $Q(z) = (p(z), q(z))$ and p, q are homogeneous polynomials of degree two. Equation (5.1) can be obtained by reduction from the general quadratic bifurcation problem $H(z, \lambda) = Q(z) - \lambda Lz + \lambda^2 c$, where L is a 2×2 constant matrix and $c \in \mathbf{R}^2$, under the following hypotheses. First we

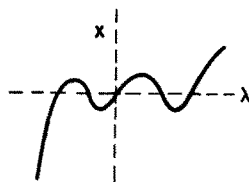

Figure 4.15. Graph of $x = \phi(\lambda)$.

Figure 4.16. Diagram associated to ϕ in Figure 4.15.

suppose that $H(z, \lambda) = 0$ has a “trivial” solution $z(\lambda)$ which depends smoothly on λ . By introducing new coordinates $\bar{z} = z - z(\lambda)$ we may eliminate the term $\lambda^2 c$ from H . Moreover, the resulting problem, which has the form $Q(z) - \lambda Lz$, is contact equivalent to (5.1) provided L is invertible, and we make this assumption. These are the restrictions placed on G by assuming it has the form (5.1).

We shall call two bifurcation problems G and \bar{G} of the form (5.1) *strongly equivalent* if there exists an invertible 2×2 matrix τ such that

$$\bar{G}(z, \lambda) = \tau^{-1} G(\tau z, \lambda) = \tau^{-1} Q(\tau z) - \lambda z.$$

This restricted form of contact equivalence will be sufficient to prove our results.

DEFINITION 5.2 The bifurcation problem (5.1) is *nondegenerate* if

- (i) p and q have no common factors,
- and
- (ii) the quadratic surfaces $p(x, y) = \lambda x$ and $q(x, y) = \lambda y$ are nowhere tangent (except at the origin).

Notes. (a) Nondegeneracy is an invariant of strong equivalence.

(b) Condition (ii) fails to be satisfied if and only if the rank of the 2×3 Jacobian matrix $d_{z, \lambda} G$ is less than 2 at some nonzero point of intersection of the two surfaces.

(c) These conditions were introduced by McLeod and Sattinger in [18].

The following lemma provides a convenient method for checking whether condition (i) above is satisfied. For this lemma let $(dQ)_z$ be the 2×2 Jacobian of the mapping $Q : \mathbf{R}^2 \rightarrow \mathbf{R}^2$ evaluated at the point z . Note that the entries of dQ depend linearly on z , so that $\det dQ$ depends quadratically on z . In other words, $\det dQ$ is a quadratic form in \mathbf{R}^2 . Thus there exists a symmetric 2×2 matrix B_Q such that $\det (dQ)_z = \langle B_Q z, z \rangle$, where $\langle \cdot, \cdot \rangle$ represents the usual inner product on \mathbf{R}^2 . Suppose $\bar{Q} = \tau^{-1} \cdot Q \circ \tau$; of course,

$$(5.3) \quad d\bar{Q}_z = \tau^{-1} \cdot dQ_{\tau \cdot z} \circ \tau$$

so that $\det d\bar{Q}_z = \det dQ_{\tau \cdot z}$. A short computation shows that $B_{\bar{Q}} = \tau' B_Q \tau$; in other words, under strong equivalence, B_Q transforms as a symmetric bilinear form.

LEMMA 5.4. *Let $Q = (p, q)$. Then p and q have a common factor if and only if $\text{rank } B_Q \leq 1$.*

Proof: If p and q have a common linear factor, then after a linear change in coordinates we may assume $p = x(ax + by)$ and $q = x(cx + dy)$. One then computes

$$B_Q = \begin{pmatrix} 2(ad - bc) & 0 \\ 0 & 0 \end{pmatrix} \quad \text{and} \quad \text{rank } B_Q \leq 1.$$

If $\text{rank } B_Q = 0$ (i.e., if $\det dQ \equiv 0$), then p is a multiple of q and hence they certainly have a common factor. Thus we suppose $\text{rank } B_Q = 1$. We may perform a linear change of coordinate to reduce B_Q to the form $\begin{pmatrix} \pm 2 & 0 \\ 0 & 0 \end{pmatrix}$. With the notation $p = ax^2 + bxy + cy^2$, $q = \alpha x^2 + \beta xy + \gamma y^2$, we find the relations $a\beta - b\alpha = \pm 2$, $a\gamma - c\alpha = 0$, $b\gamma - c\beta = 0$, from which it follows that $c = \gamma = 0$. Thus x is a common factor of p and q .

Our principal goal in this section is to enumerate all the equivalence classes of 2-determined bifurcation problems of the form (5.1). The following three propositions provide a complete solution to this problem, modulo the remarks made after Corollary 5.7. The canonical forms in Proposition 5.5 provide a useful tool for computations with such bifurcation problems. In these formulas $l(z)$ denotes a linear functional in two variables,

$$l(z) = l(x, y) = ax + by.$$

PROPOSITION 5.5. *Every nonzero bifurcation problem (5.1) is strongly equivalent to one of the following for some choice of the linear functional l :*

$$(5.6)_1 \quad (x^2 - y^2, -2xy) + (l(z) - \lambda)z,$$

$$(5.6)_2 \quad (x^2 + y^2, -2xy) + (l(z) - \lambda)z,$$

$$(5.6)_3 \quad (x^2, -2xy) + (l(z) - \lambda)z,$$

$$(5.6)_4 \quad (0, x^2) + (l(z) - \lambda)z,$$

$$(5.6)_5 \quad (l(z) - \lambda)z.$$

Moreover, no two members of different families are contact equivalent.

COROLLARY 5.7. *A nondegenerate bifurcation problem is strongly equivalent to either (5.6)₁ or (5.6)₂. Moreover, for a nondegenerate problem the coefficients a and b in the linear functional l satisfy*

$$(5.7a) \quad (a + 1)[(a - 2)^2 \mp 3b^2] \neq 0.$$

For future reference we write out $(5.6)_1$ and $(5.6)_2$ in coordinates:

$$(5.8) \quad G^\pm(x, y, \lambda) = \begin{pmatrix} (a+1)x^2 + bxy \pm y^2 - \lambda x \\ (a-2)xy + by^2 - \lambda y \end{pmatrix}.$$

Formula (5.8) represents an overenumeration of equivalence classes of bifurcation problems, in that some of the canonical forms G^\pm with different a, b are strongly equivalent. Specifically, for G^+ rotation by 120° in the a, b -plane or reflection across the a -axis yield a new canonical form strongly equivalent to the original one. Thus one need only consider a, b in a sector of opening angle 60° to get a complete enumeration of strong equivalence classes obtainable from G^+ . This is illustrated in Figure 5.1, along with the three lines on which (5.7a) fails in this case. For G^- , only the reflection $(a, b) \mapsto (a, -b)$ is a symmetry of the canonical form. For a complete enumeration of strong equivalence claims, it suffices to restrict (a, b) to the closed upper half-plane. The reader may easily supply the figure analogous to Figure 5.1 for this case, though we call attention to the fact that in this case (5.7a) only fails along the line $a = -1$ and at the point $a = 2, b = 0$.

Further collapsing of the fundamental domain occurs when we pass from strong equivalence to contact equivalence because there are new changes of coordinates available of the form $z \mapsto z - c\lambda$, where $c \in \mathbf{R}^2$, which map canonical forms with different values of (a, b) into one another. Such transformations can move the "trivial" solution away from the λ -axis and substitute another line of solutions in its place. As a consequence, two points in the

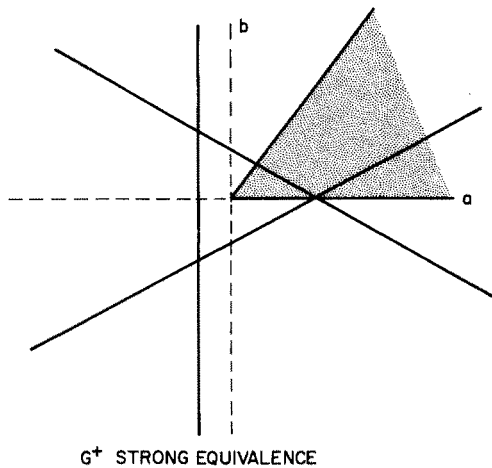

Figure 5.1. Fundamental domain for G^+ under strong equivalence.

a, b -plane that are mapped into another by the projective transformation

$$(a, b) \mapsto \left(\frac{8-a}{a+1}, \frac{3b}{a+1} \right)$$

give rise to contact equivalent canonical forms. (Of course, this operation may be composed with the other symmetries of the problem.) The fundamental domains are illustrated in Figures 5.2 and 5.3. We do not prove these remarks, since we do not feel it is important in applications to know the minimal fundamental domain.

PROPOSITION 5.9. *A nondegenerate bifurcation problem of type (5.1) is 2-determined.*

PROPOSITION 5.10. *A nondegenerate bifurcation problem of type (5.1) has codimension 7. A universal unfolding for the normal form (5.8) is given by*

$$F(x, y, \lambda, r, s, t) = G^\pm(x, y, \lambda) + (r_1 + s_1 y + s_3 x + t_1 x^2 + t_2 xy, r_2 + s_2 x - s_3 y + t_1 xy + t_2 y^2).$$

In fact, the three results, Corollary 5.7, and Propositions 5.9 and 5.10 follow from the classification Theorem 5.5. Thus our strategy will be first to assume Proposition 5.5, prove the other results, and then prove Proposition 5.5.

We shall describe an application of these results in Section 7. We also note that the McLeod–Sattinger results [18] follow directly from Proposition 5.9.

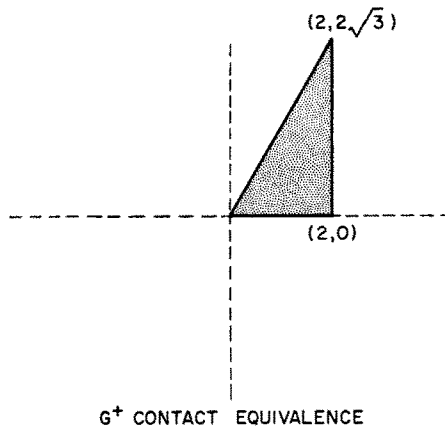

Figure 5.2. Illustration of fundamental domains, G^+ contact equivalence.

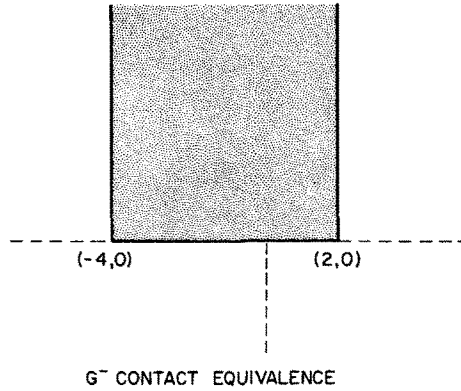

Figure 5.3. Illustration of fundamental domains, G^- contact equivalence.

Proof of Corollary 5.7: We first show that the normal forms (5.6)_{*i*} for $i = 3, 4, 5$ are degenerate. It is clear that (5.6)₅ consists of problems with common linear factors. It is also clear that condition (ii) of Definition 5.2 is invariant under all linear coordinate changes, even those which mix the λ and z coordinates. Now notice that $Q(z) + l(z) - \lambda z = Q(z) - \bar{\lambda}z$, where $\bar{\lambda} = \lambda - ax - by$. Thus the tangency of the quadratic surfaces for the problem $Q(z) + l(z)z$ is equivalent to that same question for the problem $Q(z) - \lambda z$. It is now an easy task (using note (b)) to check that the pairs of quadratic surfaces $-\lambda x = 0$, $x^2 - \lambda y = 0$ and $x^2 - \lambda x = 0$, $-2xy - \lambda y = 0$ are tangent. Consequently, the problems (5.6)₄ and (5.6)₃ are degenerate.

Finally we show that (5.6)_{*i*}, $i = 1, 2$, are degenerate only when $a = 1$ or $(a - 2)^2 \pm 3b^2 = 0$. A computation similar to the one above shows that no tangency for the quadratic surfaces occurs. To check for common factors we compute B_Q for $Q = ((a + 1)x^2 + bxy \pm y^2, (a - 2)xy + by^2)$ and apply Lemma 5.4. In fact,

$$B_Q = 2 \begin{pmatrix} (a-2)(a+1) & b(a+1) \\ b(a+1) & b^2 \mp (a-2) \end{pmatrix}.$$

Hence $\det B_Q = 4(a+1)(3b^2 \pm (a-2)^2)$.

Both Proposition 5.5 and 5.10 rely on the following:

LEMMA 5.11. *For the bifurcation problems (5.8) we have $\mathcal{M}_{z,\lambda}^3 \mathcal{E}_{z,\lambda}^2 \subset \mathcal{M}_{z,\lambda} \tilde{T}G^\pm$.*

Proof: We sketch the needed calculations. Writing $G^\pm = (g, h)$, we see that the submodule $\tilde{T}G$ of $\mathcal{E}_{z,\lambda}^2$ is generated by the six elements $\partial G/\partial x$, $\partial G/\partial y$,

$(g, 0), (0, g), (h, 0)$ and $(0, h)$. Note that $\partial G/\partial x$ in $\tilde{T}G$ implies that $(\lambda, 0) \equiv (2(a+1)x + by, (a-2)y) \pmod{\tilde{T}G}$ and $\partial G/\partial y$ in $\tilde{T}G$ implies that $(0, \lambda) \equiv (bx \pm 2y, (a-2)x + 2by) \pmod{\tilde{T}G}$. Using these relations we may eliminate λ from the problem. The four remaining generators are congruent (modulo $\tilde{T}G$) to $e_1 = ((a+1)x^2 \pm y^2, (a-2)xy)$, $e_2 = (-bx^2 + 2xy, 3x^2 - bxy \pm y^2)$, $e_3 = ((a+4)xy, (a-2)y^2)$, and $e_4 = (bxy \pm 2y^2, by^2)$.

Next write the eight generators of $\mathcal{M}_z \tilde{T}G$ — $xe_2, xe_1, ye_2, ye_1, xe_3, xe_4, ye_3, ye_4$ —in terms of the standard basis for $\mathcal{M}_z^3 \mathcal{E}_z^2$ — $(x^3, 0), (0, x^3), (x^2y, 0), (0, x^2y), (xy^2, 0), (0, xy^2), (y^3, 0), (0, y^3)$. This expansion yields an 8×8 matrix A . It is clear that the lemma is proved if and only if $\det A \neq 0$. It turns out that the determinant is not hard to compute using row and column expansions. The result is $\det A = K(a+1)(3b^2 \pm (a-2)^2)$ for some nonzero constant K . The nondegeneracy assumption is exactly what is needed to prove that $\det A \neq 0$.

Proof of Proposition 5.9: The strategy of this proof is simple. The property of being 2-determined is an invariant of contact equivalence; so we may work with the model problem (5.8). Let $H(z, \lambda)$ be a bifurcation problem whose second-order terms are given by (5.8)—for some a and b . We claim that H is contact equivalent to G + terms of degree 4 in (x, y, λ) . Since Lemma 5.11 and Theorem 2.8 imply that G is 3-determined, the above claim shows that G is, in fact, 2-determined.

To prove the claim, consider the contact change of coordinates $\bar{G} = (I + \tau(z))G(z + \rho(z), \lambda)$, where $\tau(z)$ is a matrix with linear entries in x and y , and $\rho(z)$ is homogeneous of degree two in x and y . Then $\bar{G} = G + \tau \cdot G + (d_z G) \cdot \rho + \dots$, where the dots indicate terms of degree 4 or higher. By varying τ and ρ one obtains all of the terms homogeneous of degree 3 in $\mathcal{M}\tilde{T}G$. (Here we use the homogeneity of the generators of $\tilde{T}G$.) Now, Lemma 5.11 guarantees that an appropriate choice of τ and ρ will produce $-H_3$, where H_3 is the homogeneous term of order 3 in the Taylor expansion of H . This choice of ρ and τ proves the claim and the proposition.

Proof of Proposition 5.10: Since the codimension of a bifurcation problem is an invariant of contact equivalence, we need only analyze the model problem (5.8). Lemma 5.11 shows that G has finite codimension. Next we compute a basis for $\mathcal{E}_{z,\lambda}^2/\tilde{T}G$. As noted in the proof of Lemma 5.11 this vector space is isomorphic to $V = \mathcal{E}_z^2/\{e_1, \dots, e_4\}$. Since each e_i is homogeneous of degree 2, the constant terms $(1, 0)$ and $(0, 1)$ and the linear terms $(x, 0), (y, 0), (0, x), (0, y)$ are independent in V . Since the eight terms xe_i, ye_i were shown to be independent (over \mathbf{R}), it follows that e_1, \dots, e_4 are independent over \mathbf{R} . Since there are six independent quadratic terms, two are independent in V . A calculation shows that $(x^2, xy), (xy, y^2)$ and e_1, \dots, e_4 are always independent. Thus $\dim V = 8$.

Finally we show that $\mathcal{E}_{z,\lambda}^2/TG$ has dimension 7. Observe that $\partial G/\partial \lambda$ is linear and therefore does not belong to $\tilde{T}G$. We claim, however, that

$\lambda \partial G / \partial \lambda \in \tilde{T}G$. Recalling the generators of $\tilde{T}G$ defined in the proof of Lemma 5.11, we see that (modulo $\tilde{T}G$)

$$(5.12) \quad \lambda \frac{\partial G}{\partial \lambda} = -\lambda \begin{pmatrix} x \\ y \end{pmatrix} \equiv - \begin{pmatrix} xp_x + yp_y \\ xq_x + yq_y \end{pmatrix} = -2 \begin{pmatrix} p \\ q \end{pmatrix},$$

the last equality being Euler's relation for homogeneous functions. Now $(p - \lambda x, q - \lambda y) \in \tilde{T}G$, and it follows from (5.12) that $(p - \lambda x, q - \lambda y) \equiv -(p, q)$. In conclusion, $\lambda \partial G / \partial \lambda \equiv -2(p, q) \in \tilde{T}G$, and the result is proved.

It remains only to prove the classification theorem, Proposition 5.5, for which we shall need techniques from group theory. Let \mathcal{P}_2^2 denote the vector space of pairs of homogeneous polynomials of degree two. Clearly, $\dim \mathcal{P}_2^2 = 6$. Next note that strong equivalence induces a representation ρ of $Gl(2, \mathbf{R})$ —the group of invertible 2×2 matrices—on \mathcal{P}_2^2 as follows:

$$\rho(\tau)Q = \tau^{-1} \cdot Q \circ \tau.$$

In this language one observes that finding a set of normal forms for the bifurcation problems (5.1) under strong equivalence is the same as finding an enumeration for the orbits of the representation ρ .

The first step in such an enumeration is the determination of the irreducible subspaces of the representation ρ . Let us define the linear subspaces V and W of \mathcal{P}_2^2 as follows:

$$V = \{Q \in \mathcal{P}_2^2 : \text{tr } dQ = 0\},$$

$$W = \{(ax + by) \begin{pmatrix} x \\ y \end{pmatrix} : a, b \in \mathbf{R}\}.$$

In explanation of the notation, we recall that dQ , the differential of $Q : \mathbf{R}^2 \rightarrow \mathbf{R}^2$, is a linear mapping from \mathbf{R}^2 into the space of 2×2 matrices, so that composition with the trace defines a linear functional on \mathbf{R}^2 . By the equation $\text{tr } dQ = 0$ we mean of course that this linear functional vanishes identically. This is equivalent to two scalar conditions, so $\dim V = 4$. Equation (5.3) shows that V is an invariant subspace, and a short calculation shows that ρ restricted to V is irreducible.

The action of $Gl(2, \mathbf{R})$ on W admits an alternative description. Given an element $Q(z) = l(z)z$, where l is a linear functional on \mathbf{R}^2 , $\rho(\tau)Q(z) = l(\tau z)z$. It is easily seen that ρ acts irreducibly on W . Indeed, ρ acts transitively on $W \sim \{0\}$. That is, for any two nonzero elements $Q, \bar{Q} \in W$, there exists a τ such that $\rho(\tau)Q = \bar{Q}$.

It follows from the above remarks that $\mathcal{P}_2^2 = V \oplus W$ is the decomposition into irreducible subspaces.

The second step in the enumeration of orbits in \mathcal{P}_2^2 is to analyze the orbit structure of ρ acting on V and W separately. As noted above, ρ acts

transitively on $W \sim \{0\}$, so that there is only one nontrivial orbit. To simplify the discussion of the orbits in V we invoke certain parts of the theory of group representations, as summarized in the following paragraph. For references see [22].

For any dimension l , there is a certain distinguished representation $\bar{\rho}$ of $Gl(2, \mathbf{R})$ on \mathbf{R}^l , the so-called standard representation. This representation acts by composition on \mathcal{P}_{l-1} , the space of homogeneous polynomials of degree $l-1$ in two variables; specifically, $\bar{\rho}(\tau)p = p \circ \tau$. Any other algebraic representation ρ of $Gl(2, \mathbf{R})$ on \mathbf{R}^l differs from $\bar{\rho}$ by at most a power of the determinant. That is, for any such ρ there is an invertible linear transformation $S : \mathbf{R}^l \rightarrow \mathcal{P}_{l-1}$ and an integer μ such that

$$(5.13) \quad \rho(\tau) = (\det \tau)^\mu S^{-1} \bar{\rho}(\tau) S.$$

The exponent of $\det \tau$ may be determined by comparing $\rho(cI)$ and $\bar{\rho}(cI)$ for $c \in \mathbf{R}$. When $l=4$, under the action of $\bar{\rho}$ the cubic polynomials split into a union of five distinct orbits, described by the structure of their zeros in (A)-(E) below. More properly, with a cubic polynomial $p(x, y) = ax^3 + bx^2y + cxy^2 + dy^3$, we associate the cubic polynomial in one variable $p(\zeta) = a\zeta^3 + b\zeta^2 + c\zeta + d$, and we classify orbits by the zeros of $p(\zeta)$. In this classification we use the convention that a polynomial whose leading coefficient vanishes has a real root at infinity:

- (A) p has three real zeros;
- (B) p has one real, two complex zeros;
- (C) p has two zeros, both real, one double;
- (D) p has one real zero of multiplicity three;
- (E) p vanishes identically.

For the standard representation, $\bar{\rho}(cI)$ acts as c^3 times the identity on \mathcal{P}_3 , while in our case $\rho(cI)$ acts on V as c times the identity. Thus we must take $\mu = -1$ in (5.13). However, in spite of this minor difference, V will also decompose as a union of five orbits, which we may identify by the following ruse. Recall the bilinear form B_Q that we associated to any $Q \in \mathcal{P}_2^2$, as described preceding Lemma 5.4. We showed there that $\rho(\tau)Q$ is associated with $\tau^t B_Q \tau$, a conjugacy transformation. Thus if Q_1 and Q_2 have nonconjugate associated bilinear forms, then they must belong to different orbits. Of course a bilinear form is determined up to conjugacy by two invariants, rank and signature. These invariants may assume six possible values:

	(i)	(ii)	(iii)	(iv)	(v)	(vi)
rank	2	2	2	1	1	0
signature	2	1	0	1	0	0

For four of these possibilities, (ii), (iii), (v) and (vi), there are nonzero mappings $Q \in V \subset \mathcal{P}_2^2$ such that B_Q has the appropriate rank and signature. Indeed,

$$(5.14) \quad \begin{aligned} v_1 &= (x^2 - y^2, -2xy), & v_2 &= (x^2 + y^2, -2xy), \\ v_3 &= (x^2, -2xy), & v_4 &= (0, x^2) \end{aligned}$$

are possible choices. It follows from the above remarks that these four mappings belong to four different orbits of V . Of course, the zero function v_5 belongs to a fifth. Since there are only five orbits, we have identified a representative from each. (Remark: It may be shown by a simple independent argument that, for a mapping Q with $\text{tr}dQ = 0$, B_Q cannot be of types (i) or (iv) above.)

The following lemma shows how to extract the orbit structure of ρ on \mathcal{P}_2^2 from the orbit structures on V and W .

LEMMA 5.15. *Let v_1, \dots, v_5 be representatives of the distinct orbits of ρ in V , and let*

$$\mathcal{O}_{i,w} = \{\rho(\tau)(v_i + w) : \tau \in Gl(2, \mathbf{R})\},$$

where $i = 1, \dots, 5$ and $w \in W$. Then for any orbit \mathcal{O} there exist i and w such that $\mathcal{O} = \mathcal{O}_{i,w}$. Moreover, for $i \neq j$, $\mathcal{O}_{i,w}$ is disjoint from $\mathcal{O}_{j,\bar{w}}$.

Remark. As noted after Corollary 5.7, it may happen that $\mathcal{O}_{i,w} = \mathcal{O}_{i,\bar{w}}$ even though $w \neq \bar{w}$. For the two nondegenerate cases, v_1 and v_2 as defined by (5.14), this happens only for finitely many w . Figure 5.1 indicates a domain in the a, b -plane where the enumeration is unique for the case of $i = 1$.

Proof: Suppose $\mathcal{O} \in \mathcal{P}_2^2$. We may decompose $Q = v + w$, where $v \in V$ and $w \in W$. Now $v = \rho(\tau)v_i$ for some i and for some $\tau \in Gl(2, \mathbf{R})$; let $\bar{w} = \rho(\tau^{-1})w$. Then $\rho(\tau)(v_i + \bar{w}) = v + w = Q$. In other words, $Q \in \mathcal{O}_{i,\bar{w}}$.

Any two orbits in \mathcal{P}_2^2 are either disjoint or coincide. Thus given an orbit \mathcal{O} , let us choose $Q \in \mathcal{O}$. The above construction shows that $Q \in \mathcal{O}_{i,w}$ for some i and w . Therefore, $\mathcal{O} = \mathcal{O}_{i,w}$.

Finally suppose $Q \in \mathcal{O}_{i,w} \cap \mathcal{O}_{j,\bar{w}}$. In other words, $Q = \rho(\tau)(v_i + w) = \rho(\bar{\tau})(v_j + \bar{w})$ for some $\tau, \bar{\tau} \in Gl(2, \mathbf{R})$. Hence $\rho(\tau^{-1}\bar{\tau})(v_j + \bar{w}) = v_i + w$. In particular, $\rho(\tau^{-1}\bar{\tau})v_j = v_i$, and it follows that $i = j$. Therefore, $\mathcal{O}_{i,w}$ and $\mathcal{O}_{j,\bar{w}}$ are disjoint.

We may now complete the proof of Proposition 5.5. Let $G(z, \lambda) = Q(z) - \lambda z$ be a bifurcation problem of the form (5.1). As noted above, G is strongly equivalent to another such problem, say $\bar{Q}(z) - \lambda z$, if and only if Q

and \bar{Q} belong to the same orbit of ρ in \mathcal{P}_2^2 . The preceding lemma shows that $Q \in \mathcal{O}_{i,w}$ for some i and w . Of course we also have $v_i + w \in \mathcal{O}_{i,w}$; hence it follows that G is strongly equivalent to $\bar{G}(z, \lambda) = v_i(z) + w(z) - \lambda z$. Formulas (5.6) represent the bifurcation problems $v_i + w - \lambda z$ written out in coordinates, where v_i is given by (5.14). The proof is complete, apart from the remark that the disjointness statement in Proposition 5.5 follows from the corresponding disjointness statement in Lemma 5.12.

Remark. Proposition 5.10 verifies in a special case the conjecture in Section 4 that $\text{codim } G = \text{number of defining conditions} - n - 1 + \text{modality}$. Here, $n = 2$, modality = 2, and the number of defining conditions is 8. These conditions are: $G(0) = 0$, $\partial G(0)/\partial x = 0$, $\partial G(0)/\partial y = 0$ and $\partial G(0)/\partial \lambda = 0$.

We have not yet succeeded in classifying the effects of possible imperfections on a bifurcation problem (5.1) with the same completeness as we achieved for the simpler problems in Section 4. Some idea of the difficulties involved may be gleaned from the following example which is just the negative of (5.6)₁ with $l(x) = -2x$. Let

$$(5.16) \quad G(z, \lambda) = (x^2 + y^2 + \lambda x, 4xy + \lambda y)$$

and consider the following perturbations of G :

$$P_1(z) = \varepsilon(x + y)(1, -2) \quad \text{and} \quad P_2(z) = (\varepsilon x - \frac{1}{12}\varepsilon^2, 0),$$

where ε is a small parameter. The bifurcation diagram for the unperturbed problem consists of the four lines $x = y = 0$; $x = -\lambda$, $y = 0$; and $x = -\frac{1}{4}\lambda$, $y = \pm\frac{1}{4}\sqrt{3}\lambda$. The salient points about these perturbations are that $G + P_1$ displays a singularity of type (II)₄ of Section 4 at $x = y = \lambda = 0$ and $G + P_2$ displays one of type (III) at $x = \frac{1}{6}\varepsilon$, $y = 0$, $\lambda = -\frac{1}{4}\varepsilon$. In other words, two of the more complicated singularities analyzed in Section 4 are embedded in the unfoldings of problems of type (5.1). Work is in progress to complete the analysis of imperfections in this case and will be reported elsewhere.

It is possible, however, to describe how the *unperturbed* diagram depends on the modal parameters, a and b . The regions in the a, b -plane in which (5.7a) holds are shown in Figures 5.4 and 5.5 for the minus case (formula (5.6)₁) and plus case (formula (5.6)₂), respectively. The labels in these regions should be interpreted as follows. The numerical prefix k indicates that the bifurcation diagram is a union of k lines, one of them being the trivial solution. The letters e and h refer to elliptic and hyperbolic. This label, assigned according to whether $\det dQ$ is an elliptic or a hyperbolic quadratic form, is part of the standard terminology of singularity theory (cf. [11]). The subscript 0 or ∞ serves to distinguish the bounded and unbounded components of the $4e$ region.

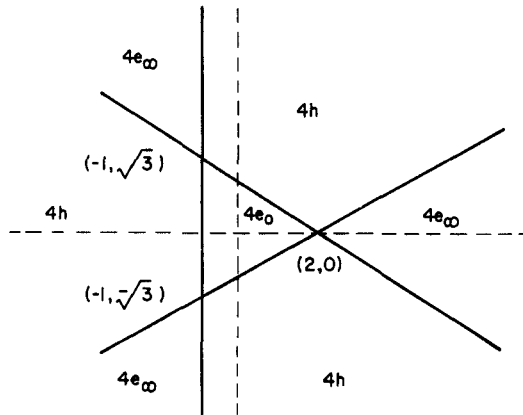

Figure 5.4. Region in the a, b -plane in which (5.7a) holds is shown for the minus case (formula (5.6)₁).

The properties of the diagrams we are going to describe are constant throughout each of these regions in the a, b -plane, as we prove in the paragraph following. Since in all nondegenerate cases the diagram consists of a union of straight lines through the origin and not contained in the plane $\{\lambda = 0\}$, we may simplify the graphics by only representing the intersection of the diagram with the plane $\{\lambda = 1\}$. In the 4-solution case this intersection consists of 4 points, one of them being the trivial solution at the origin. In the 4e cases one of the 4 points lies in the convex hull of the other three; the 4e₀

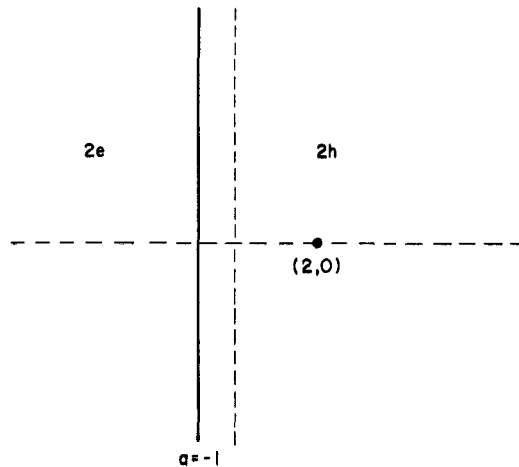

Figure 5.5. Region in the a, b -plane in which (5.7a) holds is shown for the plus case (formula (5.6)₂).

case is distinguished from the $4e_\infty$ case by the fact that the origin lies in the convex hull of the other 3. This information is represented pictorially in Figure 5.6. In this figure the boldface dots represent the solution at the origin. Although it is not possible to make stability assignments for the various branches, it is possible to assign a degree. The degree of a solution is negative if there is precisely one negative eigenvalue in $d_z G$ and positive otherwise. Note that the trivial solution always has positive degree since $d_z G$ equals $-\lambda I$ there. This is an appropriate normalization for a physical problem in which one considers bifurcation from the trivial solution as a parameter λ is varied—the trivial solution must be stable for some range of the parameter and therefore has positive degree. In Figure 5.6 we also include the analogous but simpler information for the 2-solution case.

Figure 5.6 was made by choosing a convenient representative point (a, b) from each of the regions and computing explicitly the various degrees and positions of the solutions. The only issue requiring comment is why these properties remain constant as (a, b) vary over a given region. Of course, in the case of degree, it is well known that degree is a homotopy invariant. The appropriate proof for the relative positions is based on the following trivial observation:

If $G(z, \lambda)$ is a bifurcation problem of the form (5.1) such that $G(z_i, 1) = 0$ for three distinct points z_i lying on some line Λ , then $G(z, 1) = 0$ for all $z \in \Lambda$.

To prove this, let $G = (g, h)$ be such a bifurcation problem. Then g and h restricted to Λ are both quadratic polynomials of one real variable that vanish at three distinct points. A quadratic polynomial, however, can only vanish at three points by being identically zero. This proves the claim. Note that such a G is degenerate according to Definition 5.2, in that condition (ii) is violated.

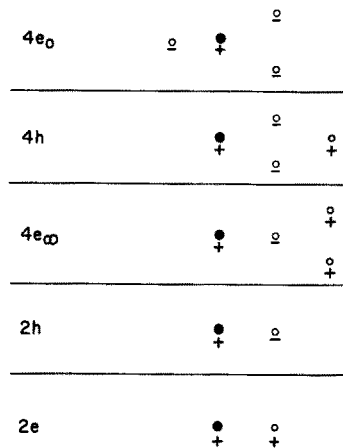

Figure 5.6. Intersection of $\{G^\pm = 0\}$ with the plane $\{\lambda = 1\}$.

Suppose now that for some choice of (a, b) one of the four points lies in the convex hull of the other three. As a and b vary, this will continue to be true unless the central point moves across the line joining two of the other three points. But by the above claim, three points can only lie on the same line if the problem is degenerate, which does not occur when a, b is restricted to a fixed region. The argument is complete.

We next consider the computation of codimension for the double cusp. By the double cusp we mean a bifurcation problem of the form

$$(5.17) \quad G(z, \lambda) = C(z) - \lambda z,$$

where $z \in \mathbf{R}^2$ and C is a homogeneous cubic polynomial, possibly with higher-order terms present. The smallest codimension that such problems can have is 16. The computation is analogous to the proof of Lemma 5.11 and we are correspondingly brief. The submodule $\tilde{T}G$ is generated by 6 elements,

$$(5.18) \quad (g, 0), (h, 0), (0, g), (0, h), \frac{\partial G}{\partial x}, \frac{\partial G}{\partial y},$$

where (g, h) are the components of G . We may use $\partial G/\partial x, \partial G/\partial y$ to eliminate λ from the problem. This leaves us with a submodule of \mathcal{E}_z^2 generated by 4 cubic elements. Let us consider the decomposition

$$\mathcal{E}_z^2 = \mathcal{P}_0^2 \oplus \mathcal{P}_1^2 \oplus \mathcal{P}_2^2 \oplus \mathcal{P}_3^2 \oplus \mathcal{P}_4^2 \oplus \mathcal{P}_5^2 \oplus \mathcal{M}^6 \mathcal{E}_z^2,$$

where \mathcal{P}_k^2 consists of pairs of polynomials in x and y homogeneous of degree k . The dimension of \mathcal{P}_k^2 and the maximum possible dimension of $\mathcal{P}_k^2 \cap \tilde{T}G$ are listed in the following table.

k	$\dim \mathcal{P}_k^2$	$\dim (\mathcal{P}_k^2 \cap \tilde{T}G)$	Difference
0	2	0	2
1	4	0	4
2	6	0	6
3	8	4	4
4	10	8	2
5	12	12	0

The maximum dimensions for $\mathcal{P}_k^2 \cap \tilde{T}G$ come from considering all homogeneous polynomials of degree $k-3$ times the 4 generators and assuming no dependencies occur. This calculation shows that $\text{codim } \tilde{T}G \geq 18$, and simple examples show that 18 is attainable.

The codimension of TG may be reduced by two from the codimension of $\tilde{T}G$ under the following circumstances. Of course, $\partial G/\partial \lambda = -(x, y)$ always

eliminates one of the linear elements of $\mathcal{E}_z^2/\tilde{T}G$. If (5.17) is modified by the addition of an appropriate quartic term, then $\lambda\partial G/\partial\lambda$ will eliminate one of the quartic elements of \mathcal{E}_z^2 , thereby reducing the codimension a second time. (It may be shown using Nakayama's lemma, Lemma 3.10 of the present paper, that the addition of quartic terms would not affect the codimension of $\tilde{T}G$.) Further reduction of the codimension is not possible.

We close this section with a brief description of the hilltop bifurcation

$$(5.19) \quad G(x, y, \lambda) = (x^2 - \lambda, y^2 - \lambda)$$

considered by Thompson and Hunt [24]. Problems equivalent to (5.19) occur in the unfoldings of (5.8). Observe that at the origin, (5.19) satisfies

$$(5.19a) \quad G = 0, \quad d_x G = 0,$$

a total of 6 equations in 3 unknowns. This observation suggests that the codimension of (5.19) is 3; indeed, this is correct, a universal unfolding being

$$(5.20) \quad F(x, y, \lambda, \alpha, \beta, \gamma) = (x^2 - \lambda - \beta y + \frac{1}{8}\alpha, y^2 - \lambda - \gamma x - \frac{1}{8}\alpha).$$

We do not classify here problems satisfying (5.19a); there are in fact three such 2-determined cases. We do, however, analyze imperfections, this being the only two-dimensional problem for which a complete analysis seems possible.

A short calculation shows that bifurcation occurs when

$$(5.21) \quad \alpha = \gamma^2 - \beta^2.$$

Recall that the equations for hysteresis points are

$$(5.22) \quad F = 0, \quad \det d_x F = 0 \quad \text{and} \quad d_{xx} F(v, v) \in \text{range } d_x F,$$

for some nonzero $v \in \ker d_x F$. For our example (5.20), (5.22) yields

$$(5.23) \quad \begin{aligned} (a) \quad & x^2 - \lambda - \beta y + \frac{1}{8}\alpha = 0, \\ (b) \quad & y^2 - \lambda - \gamma x - \frac{1}{8}\alpha = 0, \\ (c) \quad & 4xy - \beta\gamma = 0, \\ (d) \quad & (v_1^2, v_2^2) \in \text{range } d_x F, \end{aligned}$$

where $v = (v_1, v_2)$. Now assume $\beta \neq 0 \neq \gamma$. Then we may take $v = (2y, \gamma)$ and note that $w \in \text{range } d_x F$ if and only if $w \cdot (\gamma, 2x) = 0$. Equation (5.23d) implies

that

$$(5.24) \quad 2y^2 + \gamma x = 0 .$$

Next multiply (5.24) by y and substitute (5.23c) to obtain

$$(5.25) \quad y = -\frac{1}{2}\beta^{1/3}\gamma^{2/3} .$$

Using (5.23c) and (5.25) one obtains

$$(5.26) \quad x = -\frac{1}{2}\beta^{2/3}\gamma^{1/3} . .$$

Finally, subtract (5.23b) from (5.23a) and substitute (5.25) and (5.26) to obtain

$$(5.27) \quad \alpha = 3\beta^{2/3}\gamma^{2/3}(\beta^{2/3} - \gamma^{2/3}) .$$

A short computation shows that (5.27) holds even when α or β is zero.

A more involved calculation implies that double limit points occur for

$$(5.28) \quad \beta = 0, \alpha > 0 \text{ and } \gamma = 0, \alpha < 0 .$$

The control set C consisting of (5.21), (5.27) and (5.28) is shown in Figure 5.7 along with an enumeration of the 12 connected components in $\mathbf{R}^3 \sim C$. Finally, we claim that there are only two really distinct stable diagrams associated with these 12 components. To see this, note that if $(x, y, \lambda, \alpha, \beta, \gamma)$ is a solution to $F=0$, then so are $(-x, y, \lambda, \alpha, \beta, -\gamma)$, $(x, -y, \lambda, \alpha, -\beta, \gamma)$ and $(y, x, \lambda, -\alpha, \gamma, \beta)$. Using the first two symmetries, we may assume that β and

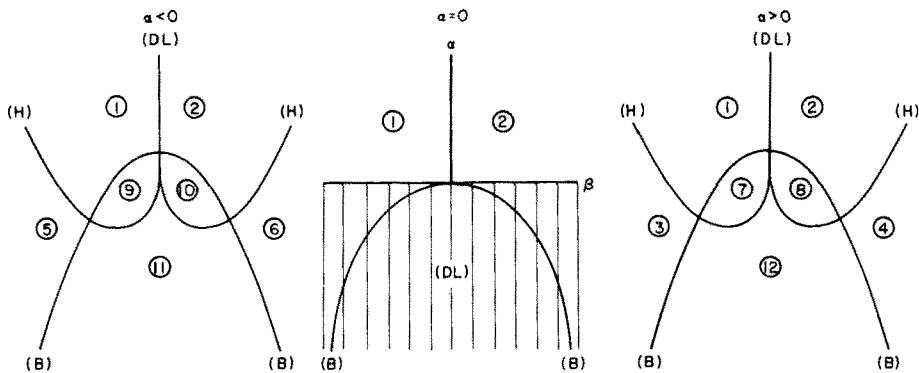

Figure 5.7. Control set C , along with an enumeration of the 12 connected components in $\mathbf{R}^3 \sim C$.

γ are positive. Thus we must analyze only the diagrams associated with regions 2, 4, 8 and 12. Points in these regions are given by $(\alpha, \beta, \gamma) = (4, 2, 0)$, $(0, 4, 2)$, $(0, 2, 4)$ and $(-4, 0, 2)$, respectively. Now using the third symmetry we need only inspect regions 2 and 8. These stable diagrams are drawn in Figures 5.8 and are analyzed by considering them as intersections of the parabolic cylinders (5.23a) and (5.23b). These cylinders are also shown in Figure 5.8.

6. The Euler Beam Problem

Recall the finite element analogue of the Euler beam problem considered in the introduction. There we exhibited two distinct perturbations of this problem which led to different behavior when applied jointly. Moreover,

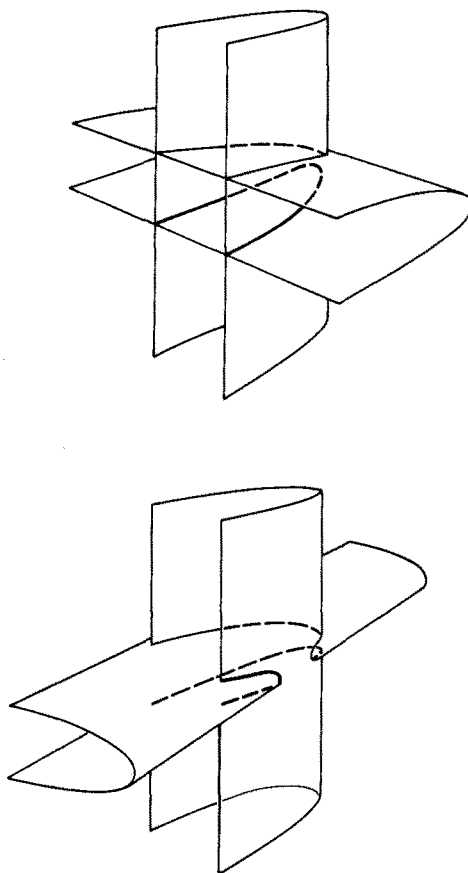

Figure 5.8. Diagrams associated with small perturbations of hilltop bifurcation.

Proposition 4.2 shows that the qualitative effects of any *small perturbation whatsoever* can be achieved by an appropriate choice of these two parameters. In the present section we derive analogous results for the continuous problem.

We consider a model which neglects the compressibility of the beam and retains only its bending rigidity, the potential energy being proportional to the integral of the square of the curvature. If the length of the rod is π , these hypotheses lead to a variational problem posed in the Sobolev space

$$\chi = \{u \in H_2(0, \pi) : u(0) = u(\pi) = 0\}.$$

Here $H_2(0, \pi)$ consists of those functions in $L^2(0, \pi)$ whose second-order distributional derivatives also belong to $L^2(0, \pi)$. A function $u(s)$ prescribes the deflection of the beam perpendicular to a reference line as a function of arc length along the beam. We consider the perturbed energy functional

$$(6.1) \quad E(u, \lambda, \alpha) = \frac{1}{2} \int_0^\pi \left[\frac{u''}{(1-u'^2)^{1/2}} - \alpha_1 \right]^2 ds + (\lambda + 1) \int_0^\pi (1-u'^2)^{1/2} ds + \alpha_2 u(\frac{1}{2}\pi).$$

For $\alpha_1 = \alpha_2 = 0$ we have the idealized problem in which the rod is perfectly straight in its unstressed position and not subjected to any external force other than the compressive force $(\lambda + 1)$ appearing in the second term in (6.1). (We have shifted the origin so that $\lambda = 0$ will be the bifurcation point.) The two parameters α_1 and α_2 represent perturbations of this idealized problem— α_1 represents a (constant) initial curvature of the beam and α_2 represents a central load.

It is well known that the idealized problem of minimizing (6.1) for $\alpha = 0$ exhibits a supercritical bifurcation at $\lambda = 0$ from the trivial solution $u = 0$. We shall give a self-contained derivation of this fact while establishing the background needed to prove that the two parameters α_1 and α_2 provide a universal unfolding of the idealized problem.

Consider the variation of $E(u, \lambda, \alpha)$ with respect to u ,

$$(6.2) \quad dE \cdot \phi = \int_0^\pi \left[\frac{u''}{(1-u'^2)^{1/2}} - \alpha_1 \right] \left[\frac{\phi''}{(1-u'^2)^{1/2}} + \frac{u' u'' \phi'}{(1-u'^2)^{3/2}} \right] ds \\ - (\lambda + 1) \int_0^\pi \frac{u'}{(1-u'^2)^{1/2}} \phi' ds + \alpha_2 \phi(\frac{1}{2}\pi).$$

Now dE is a continuous linear functional on χ , that is to say, an element of χ^* . We shall identify $L^2(0, \pi)$ with a subspace of χ^* in the standard way *via*

the L^2 inner product for $f \in L^2(0, \pi)$,

$$l_f(\phi) = \langle \phi, f \rangle = \int_0^\pi \phi f \, ds.$$

Thus χ^* may be identified with a subspace of distributions on $[0, \pi]$ that are continuous with respect to the H_2 norm. Define $\Phi : \chi \times \mathbf{R} \times \mathbf{R}^2 \rightarrow \chi^*$ so that $\Phi(u, \lambda, \alpha)$ is the linear functional on the right in (6.2). Then the Euler-Lagrange equations for the variational problem associated with (6.1) may be written symbolically as

$$(6.3) \quad \Phi(u, \lambda, \alpha) = 0.$$

Of course one may integrate by parts in (6.2) to obtain the Euler-Lagrange equations in the more standard form of a two point boundary problem,

$$(6.4) \quad \left(\frac{d}{dx}\right)^2 \left[\frac{u''}{1-u'^2} \right] - \left(\frac{d}{dx}\right) \left[\frac{u' u''^2}{(1-u'^2)^2} \right] + (\lambda + 1) \left(\frac{d}{dx}\right) \left[\frac{u'}{(1-u'^2)^{1/2}} \right] + \alpha_2 \delta_{\pi/2} = 0,$$

$$u(0) = u(\pi) = 0, \quad \frac{u''(0)}{(1-u'(0)^2)^{1/2}} = \frac{u''(\pi)}{(1-u'(\pi)^2)^{1/2}} = \alpha_1,$$

where $\delta_{\pi/2}$ is a point measure concentrated at $s = \frac{1}{2}\pi$. However, (6.4) is less convenient for our purposes, and we shall work instead with the symbolic form (6.3) of a mapping between the Hilbert spaces χ and χ^* . It is noteworthy, nonetheless, that α_1 appears only in the boundary conditions of (6.4); this is a consequence of the fact that α_1 multiplies an exact differential in (6.2).

Observe that $\Phi(0, \lambda, 0) \equiv 0$; that is, $u = 0$ is a solution of the unperturbed problem for all λ . Let $L = \overline{d\Phi}$, the differential of Φ with respect to u evaluated at $u = 0, \lambda = 0, \alpha = 0$. (Here and below we indicate by a bar various derivatives that are to be evaluated for all arguments set to zero.) Thus L is a linear map from χ into χ^* . We remark that L is singular. Indeed we have the explicit formula

$$\langle \phi, Lu \rangle = \int_0^\pi (u'' + u) \phi'' \, ds$$

for any $\phi, u \in \chi$. Note that L is a fourth-order operator, as an integration by parts, when permitted, shows. L has a one-dimensional kernel spanned by $v_0(s) = \sin s$ and a range of codimension one consisting of linear functionals

which annihilate v_0 . We may therefore use the Lyapunov–Schmidt reduction in discussing bifurcation from the trivial solution of (6.3). Let P be the orthogonal projection onto range L . Let $W(x, \lambda, \alpha)$ be the function from $\mathbf{R} \times \mathbf{R} \times \mathbf{R}^2$ into

$$\left\{ u \in \chi : \int_0^\pi uv_0 ds = 0 \right\}$$

defined by the equation

$$(6.5) \quad P\Phi(xv_0 + W(x, \lambda, \alpha), \lambda, \alpha) = 0.$$

Let $F : \mathbf{R} \times \mathbf{R} \times \mathbf{R}^2 \rightarrow \mathbf{R}$ be given by

$$(6.6) \quad F(x, \lambda, \alpha) = \langle v_0, \Phi(xv_0 + W(x, \lambda, \alpha), \lambda, \alpha) \rangle.$$

Then every solution of (6.3) has the form $xv_0 + W(x, \lambda, \alpha)$, where

$$(6.7) \quad F(x, \lambda, \alpha) = 0,$$

and conversely every solution of (6.7) yields a solution of (6.3). We shall show below that

$$(6.8) \quad \bar{F} = \bar{F}_x = \bar{F}_{xx} = \bar{F}_\lambda = 0, \quad \bar{F}_{xxx} \neq 0, \quad \bar{F}_{x\lambda} \neq 0.$$

This proves that the bifurcation of (6.3) at the origin is a pitchfork, with the canonical form (II)₃ of Section 4. We shall also prove that the determinant

$$(6.9) \quad \det(\overline{jF_x}, \overline{jF_\lambda}, \overline{jF_{\alpha_1}}, \overline{jF_{\alpha_2}}) \neq 0,$$

where, for any function F , jF is defined before Lemma 4.3. This will complete the proof that α_1 and α_2 are non-degenerate unfolding parameters for the idealized problem $\Phi(u, \lambda, 0) = 0$.

It remains to compute a number of derivatives of F at the origin. We use the subscript notation for derivations except that we abbreviate F_{α_i} by F_i , $i = 1, 2$. The three parameters λ, α_1 and α_2 enter into the derivatives on a more or less equal footing and we write F_c for a derivation with respect to one of these three parameters when it is convenient not to specify which. By $d^k\Phi$ we mean the multi-linear functionals that arise from higher-order differentiation (with respect to u). Let L^{-1} be the generalized inverse of L , defined to be zero on the orthogonal complement of range L . Thus $L^{-1}P = L^{-1}$.

Let us write $\Phi(u, \lambda, \alpha) = Lu + \Psi(u, \lambda, \alpha)$, where $\Psi(\cdot, 0, 0)$ vanishes to third order in u . More explicitly we have

$$(6.10) \quad \Psi(u, \lambda, \alpha) = C(u) + \lambda Mu + \alpha_1 A(u) + \alpha_2 \delta_{\pi/2} + \text{h.o.t.},$$

where

$$(6.11) \quad \langle \phi, C(u) \rangle = \int_0^\pi \{u'^2 u'' \phi'' + [u' u''^2 - \frac{1}{2} u'^3] \phi'\} ds,$$

$$(6.12) \quad \langle \phi, Mu \rangle = \int_0^\pi u'' \phi ds,$$

$$(6.13) \quad \langle \phi, A(u) \rangle = [1 - u'(0)^2]^{-1/2} \phi'(0) - [1 - u'(\pi)^2]^{-1/2} \phi'(\pi).$$

The higher-order terms in (6.10) do not contribute to the derivatives needed below. We collect here a number of relations which follow from (6.10)–(6.13):

$$(6.14) \quad \overline{d\Psi} = 0, \quad \overline{d^2\Psi} = 0, \quad \overline{d^3\Psi} = d^3C,$$

$$(6.15) \quad \overline{\Psi_\lambda} = 0, \quad \overline{d(\Psi_\lambda)} = M, \quad \overline{d^2(\Psi_\lambda)} = 0,$$

$$(6.16) \quad \overline{\Psi_1} = \delta'_0 - \delta'_\pi, \quad \overline{d(\Psi_1)} = 0,$$

$$\overline{d^2(\Psi_1)}(w_1, w_2) = w'_1(0)w'_2(0)\delta'_0 - w'_1(\pi)w'_2(\pi)\delta'_\pi,$$

$$(6.17) \quad \overline{\Psi_2} = \delta_{\pi/2}, \quad \overline{d(\Psi_2)} = 0, \quad \overline{d^2(\Psi_2)} = 0.$$

We begin by computing some of the derivatives of $W(x, \lambda, \alpha)$, the non-singular part of the bifurcation problem, defined in (6.5).

LEMMA 6.18. $\overline{W_x} = \overline{W_{xx}} = 0$, $\overline{W_c} = -L^{-1}\overline{\Psi_c}$. In particular, $\overline{W_\lambda} = 0$, since $\overline{\Psi_\lambda} = 0$.

Proof: We may rewrite (6.5) in our present notation as

$$(6.19) \quad LW(x, \lambda, \alpha) + P\Psi(xv_0 + W(x, \lambda, \alpha), \lambda, \alpha) = 0.$$

Differentiating (6.19) with respect to x we obtain

$$(6.20) \quad LW_x + P \cdot d\Psi \cdot (v_0 + W_x) = 0.$$

We deduce that $LW_x = 0$ from (6.20) by setting all arguments equal to zero and appealing to the first relation in (6.14) to discard the second term in (6.20). Since $W \in (\ker L)^\perp$, it follows that $\bar{W}_x = 0$. The second and third relations of the lemma may be obtained similarly by differentiation of (6.20) and (6.19) with respect to x and c , respectively. The proof is complete.

The next lemma shows that the underlying bifurcation diagram is a pitchfork.

LEMMA 6.21. *The relations (6.8) are satisfied.*

Proof: Note that (6.6) may be rewritten as

$$(6.22) \quad F(x, \lambda, \alpha) = \langle v_0, \Psi(xv_0 + W(x, \lambda, \alpha), \lambda, \alpha) \rangle$$

since $\langle v_0, L_u \rangle = 0$ for any u . Differentiation of (6.22) with respect to x yields

$$F_x = \langle v_0, d\psi \cdot (v_0 + W_x) \rangle.$$

Evaluation at the origin shows that $\bar{F}_x = 0$, when an appeal to (6.14) is made. Continued differentiation yields $\bar{F}_{xx} = 0$ and

$$(6.23) \quad \bar{F}_{xxx} = \langle v_0, d^3 C(v_0, v_0, v_0) \rangle.$$

In deriving (6.23) we have used (6.14) and Lemma 6.18 to discard a number of terms which vanish. We see from (6.11) that

$$\langle v_0, d^3 C(v_0, v_0, v_0) \rangle = 6 \int_0^\pi (2 \sin^2 s \cos^2 s - \frac{1}{2} \cos^4 s) ds = \frac{3}{8} \pi,$$

which is non-zero as claimed. In a similar fashion, differentiation with respect to λ leads to the conclusion that $\bar{F}_\lambda = 0$ and

$$\bar{F}_{\lambda x} = \langle x_0, \overline{d(\Psi_\lambda)} \cdot v_0 \rangle.$$

It follows from (6.15) and (6.12) that

$$(6.24) \quad \bar{F}_{\lambda x} = \int_0^\pi v_0(s) v_0''(s) ds = - \int_0^\pi \sin^2 s ds = -\frac{1}{2} \pi.$$

This completes the proof.

Our strategy in evaluating the determinant (6.9) is to show that the last row contains only one non-zero element and that the second column contains only one non-zero element. Expansion in minors will then reduce to a 2×2 determinant.

LEMMA 6.25. $\bar{F}_{\lambda\lambda} = \bar{F}_{1\lambda} = \bar{F}_{2\lambda} = 0$.

Proof: By differentiating (6.22) we may obtain the formula

$$(6.26) \quad \bar{F}_{cd} = \langle v_0, \overline{d(\Psi_c)} \cdot \bar{W}_d + \overline{d(\Psi_d)} \cdot \bar{W}_c \rangle$$

for any second-order derivative with respect to the parameters $\lambda, \alpha_1, \alpha_2$. It follows immediately from Lemma 6.18 that $\bar{F}_{\lambda\lambda} = 0$. On substituting (6.15), (6.16) and Lemma 6.18 into (6.26) we find

$$\bar{F}_{1\lambda} = -\langle v_0, M \cdot L^{-1} \cdot (\delta'_0 - \delta'_\pi) \rangle.$$

Integration by parts allows us to shift M to operate on the first factor in the inner product; since $Mv_0 = -v_0$ we see that

$$\bar{F}_{1\lambda} = \langle v_0, L^{-1} \cdot (\delta'_0 - \delta'_\pi) \rangle,$$

which vanishes by the definition of the generalized inverse L^{-1} . A similar argument shows that $\bar{F}_{2\lambda} = 0$. The proof is complete.

LEMMA 6.27. $\bar{F}_\lambda = \bar{F}_{\lambda xx} = \bar{F}_{\lambda\lambda} = 0$.

Proof: Only the middle equality is new. We may differentiate as above to obtain

$$(6.28) \quad \bar{F}_{\lambda xx} = \langle v_0, \overline{d^3\Psi}(\bar{W}_\lambda, v_0, v_0) + \overline{d^2(\Psi_\lambda)}(v_0, v_0) \rangle.$$

But $\bar{W}_\lambda = 0$ by Lemma 6.18 and $\overline{d^2(\Psi_\lambda)} = 0$ by (6.15), so the lemma is proved.

Because of the numerous zero elements exhibited in the preceding two lemmas, the determinant in (6.9) equals

$$F_{\lambda x}^2 \det \begin{pmatrix} \bar{F}_1 & \bar{F}_2 \\ \bar{F}_{1xx} & \bar{F}_{2xx} \end{pmatrix}.$$

It is straightforward that

$$\bar{F}_1 = \langle v_0, \bar{\Psi}_1 \rangle = \langle v_0, \delta'_0 - \delta'_\pi \rangle = 2,$$

and

$$\bar{F}_2 = \langle v_0, \bar{\Psi}_2 \rangle = \langle v_0, \delta_{\pi/2} \rangle = 1.$$

Proceeding to the second row, we have

$$(6.29) \quad \bar{F}_{1xx} = \langle v_0, \overline{d^3\Psi}(\bar{W}_1, v_0, v_0) + \overline{d^2\Psi}_1(v_0, v_0) \rangle,$$

a formula analogous to (6.28). By (6.16) the second term in (6.29) equals

$$v'_0(0)^2 \langle v_0, \delta'_0 \rangle - v'_0(\pi) \langle v_0, \delta'_\pi \rangle = 2.$$

By (6.14) we may replace $\overline{d^3\Psi}$ by d^3C in the first term of (6.29). It follows from (6.11) that, for any $u \in \chi$,

$$\langle \phi, d^3C(u, v_0, v_0) \rangle = \int_0^\pi \{ [2v_0'^2 u'' + 4v_0'' v_0' u'] \phi'' + [4v_0'' v_0' u'' + 2v_0''^2 u' - 3v_0'^2 u'] \phi' \} ds.$$

On substituting $\phi(s) = v_0(s) = \sin s$ and integrating by parts we find that

$$(6.30) \quad \langle v_0, d^3C(u, v_0, v_0) \rangle = 3 \int_0^\pi (7 \sin s \cos^2 s - 2 \sin^3 s) u(s) ds.$$

We recall that $1 - \cos^2 s = \sin^2 s$ and that

$$\sin^3 s = \frac{1}{4}(3 \sin s - \sin 3s).$$

Using these relations we can show that the left-hand side of (6.30) equals

$$(6.31) \quad \frac{27}{4} \int_0^\pi \sin(3s) u(s) ds + \frac{3}{4} \int_0^\pi \sin s u(s) ds.$$

We want to evaluate (6.31) with

$$u = \bar{W}_1 = -L^{-1}(\delta'_0 - \delta'_\pi).$$

The second integral in (6.31) vanishes, since the range of L^{-1} is orthogonal to v_0 . In the first integral, L^{-1} may be shifted to operate on $\sin 3s$. But $\sin 3s$ is

an eigenfunction of L , hence of L^{-1} , and

$$L^{-1} \sin 3s = \frac{1}{72}(\sin 3s).$$

Combining we find

$$\langle v_0, d^3 C(\bar{W}_1, v_0, v_0) \rangle = -\frac{3}{32} \langle \sin 3s, \delta'_0 - \delta'_\pi \rangle = -\frac{9}{16}.$$

Taking both terms in (6.31) we have $\bar{F}_{1xx} = \frac{23}{16}$.

The computation of \bar{F}_{2xx} is similar but slightly simpler in that $\overline{d^2 \Psi_\beta} = 0$ so that the analogue of (6.29) will contain only one term. One finds $F_{2xx} = \frac{3}{32}$ and the determinant (6.9) equals $-\frac{3}{4} \bar{F}_{\lambda x}^2$. This completes the proof that α_1 and α_2 provide a universal unfolding for the idealized beam problem.

7. Examples

In this section we collect a number of physical problems in which a bifurcation equivalent to one of the canonical forms of Sections 4 and 5 occurs. The section is divided into two parts, which illustrate systems with one or with several essential degrees of freedom. Our choice of examples is only intended to be illustrative, and we make no pretense of being exhaustive.

a. One essential degree of freedom. Some of the simpler one-dimensional singularities are amply documented in the literature. Thompson and Hunt [25] is a good reference here. For example, a bifurcation equivalent to the canonical form (I) with $m = 2$ (notation of Section 4) is called a *limit point* by these authors. The shallow arch is a simple physical system which exhibits this kind of behavior. In its finite element analogue the shallow arch consists of two springs pinned as shown in Figure 7.1 and subjected to a transverse force λ , which is the bifurcation parameter. Suppose that the distance $|AB|$ between the two external supports is less than the combined uncompressed length of the two springs. Then for $\lambda = 0$ the system will have three equilibrium configurations, two stable ones with the center pin C located either above or below the line AB and one unstable one with C located on AB . For general λ the diagram of equilibrium states will have the form illustrated in Figure 7.2, where the dashed portions indicate unstable states. This system has a bifurcation diagram of the limit point type at either of the points P or Q in the figure. Such diagrams are stable, and no unfolding parameters are required. (Moreover, Theorem 2.15 indicates that limit points will occur in the stable diagrams perturbed off any bifurcation problem whatsoever.)

Thompson and Hunt [26] use the term *asymmetric point of bifurcation* for a bifurcation equivalent to the canonical form (II) with $m = 2$. This type of

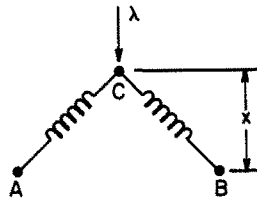
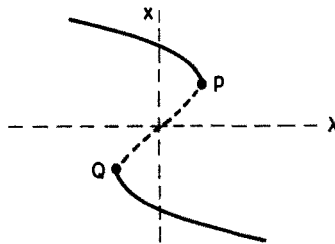

Figure 7.1. Illustration of pinning of two springs.

bifurcation is exhibited, for example, in the buckling of a curved plate, or more simply, in the buckling of a column supported by a nonlinear spring, the model introduced by von Kármán to explain the former problem. (See the discussion in Chapter VIII of [23].) The simplest finite element analogue of this model is illustrated in Figure 7.3. This model differs from the beam problem, considered in the introduction, by the presence of the horizontal supporting spring. The spring is supposed to be unstressed when the beam is perfectly straight. Let $F(x) = -(k_1x + k_2x^2 + k_3x^3)$ be the force exerted by the spring as a function of the displacement from equilibrium x . It is essential that k_2 be nonzero in order to have an asymmetric point of bifurcation. A more quantitative discussion is given in [13] or [23]. The bifurcation diagram for this problem (*near the bifurcation point*) is illustrated in Figure 7.4.

The asymmetric point of bifurcation was observed by Benjamin [5] in his study of the Taylor problem in an annulus of finite length. Benjamin considered a one-parameter family of bifurcation problems, the parameter being the length of the annulus containing the fluid. He advanced the hypothesis that diagrams with bifurcation (i.e., a crossing of two solution branches) should only occur for a discrete set of parameter values, and that, in the absence of symmetry, the asymmetric point of bifurcation should be expected when bifurcation does occur. Our results support this hypothesis, in the following points. We have shown that any diagram in which bifurcation occurs has codimension at least one and therefore cannot be stable. Also, we proved that the asymmetric point of bifurcation has codimension exactly one

Figure 7.2. Diagram of equilibrium states for general λ .

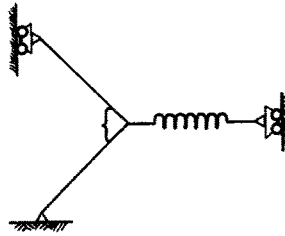

Figure 7.3. Illustration of the simplest finite-element analogue of the model introduced by von Kármán.

with respect to arbitrary perturbations. Thus an asymmetric point of bifurcation can occur stably within a one-parameter family of problems. The pitchfork (symmetric point of bifurcation in the terminology of [26]) has codimension 2, and other singularities still higher codimension. It seems unlikely, therefore, that a pitchfork bifurcation will be seen in an experiment where only one parameter is varied, at least in the absence of some symmetry that limits the perturbations which are appropriate. Further supporting evidence for this conclusion is provided by the recent result of Saut and Téman [8], that for generic boundary data and fixed Reynolds numbers the stationary Navier–Stokes equations have only finitely many solutions.

We observed in the introduction that an asymmetric point of bifurcation can result from an arbitrarily small perturbation of the standard pitchfork.

The canonical form associated with the standard pitchfork is of course (II) with $m = 3$. The Euler beam problem, discussed in Section 6, provides an illustration of this singularity, if indeed any illustration is needed.

The other canonical forms in Section 4 perhaps require more explanation. One might well question whether example (I) with $m = 3$ is properly called a bifurcation phenomenon at all. This singularity is not included on the list of Thompson and Hunt [26], and it does not involve the crossing of two solution branches. If, however, one accepts the definition of bifurcation phenomena as phenomena where the number of solutions of the governing equations as a function of a parameter λ can be changed by an arbitrarily small perturbation, then it is appropriate to include this example in a study of bifurcation

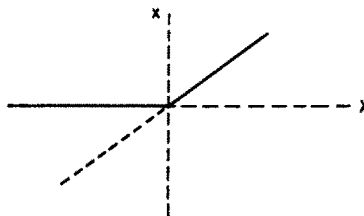

Figure 7.4. Bifurcation diagram.

theory; and we take this point of view. Indeed, consider the unfolding of this example

$$(7.1) \quad F(x, \lambda, \alpha) = x^3 + \alpha x + \lambda.$$

If $\alpha > 0$, then for every λ the equation

$$(7.2) \quad F(x, \lambda, \alpha) = 0$$

has a unique (real) solution $x(\lambda)$ which, moreover, is a smooth function of λ . If $\alpha < 0$, then (7.2) has one solution for $|\lambda|$ large and three solutions for λ near zero—the bifurcation diagram will in fact resemble Figure 7.2. Hysteresis can be observed in this system by varying the bifurcation parameter λ back and forth across a neighborhood of zero. This is the simplest example of a *hysteresis point*, as described in the introduction. Such a point marks the onset of possible hysteresis in the system as the unfolding parameter is varied.

We refer to Example 1.9.1 on page 38 of Gavalas [5] for an occurrence of a hysteresis point in a physical problem. (We are grateful to B. Keyfitz for calling this example to our attention, and even more so, for explaining it to us.) Gavalas considers an irreversible, exothermic, volume-preserving reaction involving only one reactant and taking place in a stirred tank in which the reactant is added to the tank at a constant rate and withdrawn from the tank at the same rate (see Figure 7.5). The concentration and temperature of the output are assumed to be equal to those of the tank as a whole—this is what is meant by a stirred tank. Let C_f and T_f be the feeder concentration and temperature, respectively. Under the above idealized hypotheses the output concentration and temperature as functions of time satisfy the following system of ordinary differential equations:

$$(7.3) \quad \begin{aligned} \frac{dC}{dt} &= \frac{1}{\theta} (C_f - C) - K_1 f(C, T), \\ \frac{dT}{dt} &= \frac{1}{\theta} (T_f - T) + K_2 f(C, T), \end{aligned}$$

where $f(C, T) = C \exp \{-K_3/T\}$ and θ is the so-called holding time, the

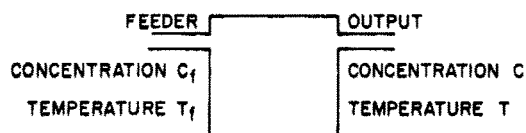

Figure 7.5. Schematic diagram for model chemical reactor.

volume of the tank divided by the feeder rate. Here K_1, K_2, K_3 are physical constants. The equations for equilibrium solutions of (7.3) are obtained by setting the left-hand side equal to zero. On introducing non-dimensional variables and simplifying, one is led to the equation governing equilibrium conditions

$$(7.4) \quad F(x, \lambda, \alpha, \beta) = \log\left(\frac{1-x}{x}\right) - \frac{1}{\alpha + \beta x} + \lambda = 0,$$

where α and β are the non-dimensional feeder temperature and concentration, λ is the logarithm of the non-dimensional holding time, and x is the so-called extent, the fraction of the reactant concentration consumed while the reactant is inside the tank. These variables are restricted to the following ranges:

$$(7.5) \quad 0 < x < 1, \quad -\infty < \lambda < \infty, \quad \alpha > 0, \quad \beta > 0.$$

Equation (7.4) possesses a one-parameter family of hysteresis points. If x_0 is any point in the interval $(0, \frac{1}{2})$, the parameters α, β and λ may be assigned values so that

$$(7.6) \quad F = F_x = F_{xx} = 0$$

at the point $(x_0, \lambda_0, \alpha_0, \beta_0)$. In fact α_0 and β_0 may be chosen to satisfy the last two equations, and then λ_0 may be chosen to satisfy the first. There is a possible difficulty in that $x_0, \lambda_0, \alpha_0, \beta_0$ are subject to the restrictions (7.5), but if $0 < x_0 < \frac{1}{2}$, the computed values for the other variables will be consistent with (7.5). It is easily verified that $F_{xxx} \neq 0$ and obvious that $F_\lambda \neq 0$; this shows that we have indeed found a family of hysteresis points (see Proposition 4.1).

The reader may readily check that, at the hysteresis points discussed above, $F_{\alpha x} < 0$ and $F_{\beta x} > 0$. It follows that if, starting from a hysteresis point, α (feeder temperature) is increased or β (feeder concentration) is decreased then hysteresis sets in. This hysteresis can be observed physically in quasi-static variations of λ (i.e., of the feeder rate).

Hysteresis points were observed by Benjamin [5] in the paper mentioned earlier, and they also occur in the model for buckling of a curved plate [23], although the viewpoint there is quite different from ours.

The following beautiful example illustrates both the canonical forms (II)₅ and (III). It is taken from Poston and Stewart's forthcoming book [19]; we are indebted to them for generously sending us part of their manuscript. Let us modify the finite element analogue of a buckling beam considered in the introduction by allowing both of the connecting links to be compressible (see Figure 7.6). Suppose in fact that the connecting links are linear springs with

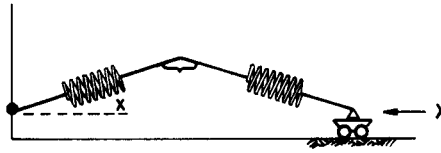

Figure 7.6. Finite element analogue for buckling strut with compressible links.

equal spring constants k and uncompressed length unity. For simplicity let us assume that there is a supporting frame (not shown in the figure) that forces the two springs to have equal compression or extension; this does not change the basic conclusion but it simplifies the analysis, eliminating an inessential degree of freedom. Choose as coordinates x , the angle the links make with the reference line, and X , the common length of the springs. Then the potential energy is

$$V = k(X - 1)^2 + \frac{1}{2}x^2 + 2\lambda X \cos x,$$

and the equations for equilibrium are

$$(7.7) \quad \begin{aligned} \frac{\partial V}{\partial x} &= x - 2\lambda X \sin x = 0, \\ \frac{\partial V}{\partial X} &= 2k(X - 1) + 2\lambda \cos x = 0. \end{aligned}$$

If the second equation in (7.7) is used to eliminate X from this system (a trivial instance of the Lyapunov-Schmidt reduction) we are left with the equation

$$(7.8) \quad F(x, \lambda) = 2\lambda(1 - (\lambda/k) \cos x) \sin x - x = 0.$$

Bifurcation can occur from the solution $x = 0$ of (7.8) only if

$$F_x = -(2\lambda^2/k - 2\lambda + 1) = 0,$$

that is, only if

$$(7.9) \quad \lambda = \frac{1}{2}\{k \pm (k^2 - 2k)^{1/2}\}.$$

Thus for $k > 2$ there are two distinct bifurcations and for $k < 2$, none. It is readily seen that

$$F = F_x = F_{xx} = F_\lambda = 0$$

at each of the bifurcation points (7.9), and thus each of them is at least as singular as the pitchfork. Calculation shows that

$$\begin{aligned} F_{xxx} &= 2\lambda(4\lambda/k - 1), \\ F_{\lambda x} &= 2(1 - 2\lambda/k). \end{aligned}$$

If the plus sign is chosen in (7.9), then F_{xxx} is positive and $F_{\lambda x}$ is negative, regardless of the value of $k > 2$. If the minus sign is chosen, then F_{xxx} is negative for $k > \frac{8}{3}$ and positive for $k < \frac{8}{3}$ while $F_{\lambda x}$ is positive for all $k > 2$. We leave it to the reader to verify these statements.

Consider what happens to the bifurcation diagram as k is decreased from large positive values. For k large there are two bifurcations, approximately at $\lambda_{\min} = \frac{1}{2} + k^{-1}$ and at $\lambda_{\max} = k$, as illustrated in Figure 7.7(a). The bifurcation at λ_{\min} is a small perturbation of the bifurcation of the rigid system of Section 1, while the bifurcation at λ_{\max} requires compressing the springs to almost zero length. Both bifurcations are supercritical, since F_{xxx} and $F_{\lambda x}$ have opposite signs. For $k < \frac{8}{3}$ the bifurcation at λ_{\min} becomes subcritical, with of course a loss of stability for the branching solutions. For $k = \frac{8}{3}$ the cubic term in the equation vanishes, and we are faced with a higher-order singularity—specifically, example (II) with $m = 5$. (The conditions of Theorem 4.1 are readily verified.) The behavior presented here is perhaps the best way to conceptualize this canonical form—as one of the parameters in its unfolding is varied the associated diagram changes from subcritical to supercritical.

As k is further decreased the two bifurcation points collide and the branching solutions no longer intersect the axis of symmetry. No bifurcations occur for $k < 2$. This is as it should be, since for k small, stronger restoring forces are associated with rotating the springs than with compressing them. Note that at the transition point we have $F_{\lambda x} = 0$ but $F_{\lambda\lambda x} \neq 0$. We shall show that at this point, namely $k = 2$, $\lambda = 1$, equation (7.8) is in fact equivalent to the canonical form (III) of Section 4.

Here also the behavior of the physical system provides a conceptualization of the singularity—as one of the parameters of the unfolding is varied, two adjacent pitchfork bifurcation points merge and then form a disconnected diagram.

Observe that

$$F(x, \lambda) = \frac{1}{3}(2\lambda^2 - \lambda)x^3 - (\lambda - 1)^2x + O(x^5).$$

Multiplication of this function by $[\frac{1}{3}(2\lambda^2 - \lambda)]^{-1}$ gives an equivalent function, and if we define a new variable by $\bar{\lambda} = [\frac{1}{3}(2\lambda^2 - \lambda)]^{-1/2}(\lambda - 1)$ we obtain a new function

$$(7.10) \quad G(x, \bar{\lambda}) = x^3 - \bar{\lambda}^2x + O(x^5).$$

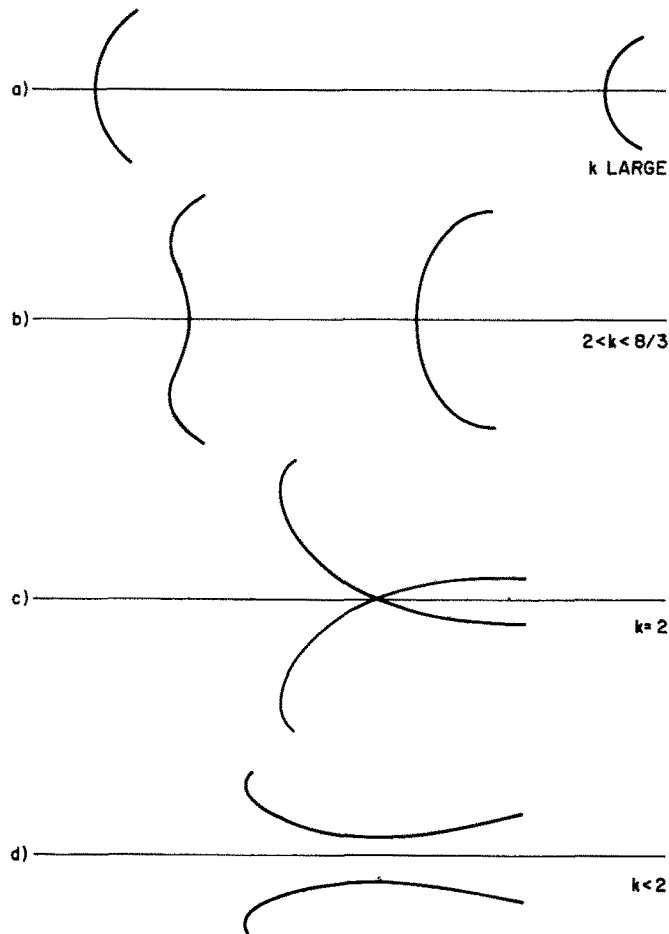

Figure 7.7. Bifurcation diagrams associated to system in Figure 7.6.

We now appeal to Proposition 3.10. Consider the ideal J generated by $x^3 - \bar{\lambda}^2 x$ and its derivative, $3x^2 - \bar{\lambda}^2$. Clearly $\mathcal{M}^4 \subset J$, so that, according to the proposition, any perturbation by an element of $\mathcal{M}^5 \subset \mathcal{M}J$ will still be equivalent to $x^3 - \bar{\lambda}^2 x$. The perturbation in (7.10) obviously belongs to \mathcal{M}^5 , so $x^3 - \lambda^2 x$ is indeed the relevant canonical form.

b. Two essential degrees of freedom. We only discuss one problem in any detail, the one-dimensional reaction-diffusion equations associated to the so-called tri-molecules model of Lefever and Prigogine [14]. We are deeply grateful to Giles Auchmuty for suggesting this problem as a possible

application of our theory. The relevant equations are

$$(7.11) \quad \begin{aligned} \frac{\partial X}{\partial t} &= D_1 \frac{\partial^2 X}{\partial x^2} + X^2 Y - (B+1)X + A, \\ \frac{\partial Y}{\partial t} &= D_2 \frac{\partial^2 Y}{\partial x^2} - X^2 Y + BX, \end{aligned}$$

subject to the boundary conditions of Dirichlet type

$$(7.12) \quad X(0) = X(\pi) = A, \quad Y(0) = Y(\pi) = B/A.$$

Here the unknown functions X and Y are chemical concentrations, A and B are constant, externally controlled chemical concentrations, and D_1 , D_2 are diffusion coefficients. We are interested in time-independent, non-negative solutions of (7.11), (7.12), particularly in the dependence of such solutions on the parameter B , which we take as the bifurcation parameter.

First, let us consider the ordinary differential equation associated with space-independent solutions of (7.11),

$$(7.13) \quad \begin{aligned} \frac{dX}{dt} &= X^2 Y - (B+1)X + A, \\ \frac{dY}{dt} &= -X^2 Y + BX. \end{aligned}$$

This system has a unique rest point at $X = A$, $Y = B/A$. We define

$$(7.14) \quad X = A + u, \quad Y = B/A + v$$

and compute that u , v satisfy an equation near $u = v = 0$ whose linear part is

$$(7.15) \quad \begin{pmatrix} \frac{du}{dt} \\ \frac{dv}{dt} \end{pmatrix} = \begin{pmatrix} B-1 & A^2 \\ -B & -A^2 \end{pmatrix} \begin{pmatrix} u \\ v \end{pmatrix}.$$

It is easily seen that the eigenvalues of the matrix in (7.15) have negative real part if and only if

$$(7.16) \quad B < 1 + A^2.$$

Thus if (7.16) is satisfied, then $X = A$, $Y = B/A$ is a local attractor for (7.13).

In fact, it may be shown (cf. [2]) that if (7.16) is satisfied, this rest point is a global attractor for (7.13). For values of B not satisfying (7.16), equation (7.13) has an attracting limit cycle which encloses the unstable rest point at $(A, B/A)$. A Hopf bifurcation occurs for $B = 1 + A^2$, connecting the two regimes.

Because of our choice of boundary conditions in (7.12), the rest point $X = A$, $Y = B/A$ of (7.13) also provides a solution to the boundary problems for the partial differential equations (7.11), (7.12). To discuss the stability of this solution we again define u , v by (7.14) and compute that u , v can satisfy an equation whose linear part is

$$(7.17) \quad \begin{pmatrix} u_t \\ v_t \end{pmatrix} = \begin{pmatrix} D_1 & 0 \\ 0 & D_2 \end{pmatrix} \begin{pmatrix} u_{xx} \\ v_{xx} \end{pmatrix} + \begin{pmatrix} B-1 & A^2 \\ -B & -A^2 \end{pmatrix} \begin{pmatrix} u \\ v \end{pmatrix}.$$

We must determine the spectrum of the linear operator L appearing on the right in (7.17), a linear operator, say, on $L^2(0, 1) \oplus L^2(0, 1)$ with homogeneous Dirichlet boundary conditions. Since L commutes with $(\partial/\partial x)^2$, the eigenfunctions of L may be assumed to have the form

$$(7.18) \quad w(x) = \psi(x) \begin{pmatrix} a \\ b \end{pmatrix},$$

where a, b are constants and ψ is an eigenfunction of $(\partial/\partial x)^2$, say, $\psi''(x) = -\mu\psi(x)$. The two eigenvalues of L associated with eigenfunctions of the form (7.18) are the eigenvalues of the matrix

$$(7.19) \quad \begin{pmatrix} B-1-\mu D_1 & A^2 \\ -B & -A^2-\mu D_2 \end{pmatrix}.$$

Observe that (7.19) has zero as an eigenvalue if and only if

$$(7.20) \quad B = 1 + \frac{D_1}{D_2} A^2 + D_1 \mu + \frac{A^2}{D_2 \mu}.$$

In conclusion, the linearization of (7.11) about the trivial solution is singular only for values of B which satisfy (7.20), where μ is an eigenvalue of $-(\partial/\partial x)^2$. Only for values of B which satisfy (7.20) can one expect nontrivial, time-independent solutions of (7.11), (7.12) to bifurcate from the trivial solution $X = A$, $Y = B/A$. We emphasize that the bifurcations coming from (7.20) are associated with time-independent solutions of (7.11), (7.12), in contrast to the Hopf bifurcation of the ordinary differential equation.

Let us define a function $B(\mu)$ by the right-hand side of (7.20). A calculus argument shows that

$$(7.21) \quad \min_{\mu} B(\mu) = (1 + (D_1/D_2)^{1/2}A)^2.$$

On comparison with (7.16), one sees that the partial differential equation can lose stability with respect to spatially dependent perturbations at values of B considerably smaller than where the ordinary differential equation loses stability, provided D_2 is rather larger than D_1 . A more complete analysis (cf. [3]) shows that for B in the range (7.16) the only possible bifurcations from the trivial solution, into either time-independent or time-dependent states, are the bifurcations associated with (7.20).

The eigenvalues of $-(\partial/\partial x)^2$ on $(0, \pi)$ are $\mu = l^2$, $l = 1, 2, 3, \dots$, associated with the eigenfunction $\sin lx$. Thus (7.21) only represents a lower bound on the value of B at which the partial differential equation loses stability, the exact value being

$$(7.22) \quad \min \{B(l^2) : l = 1, 2, 3, \dots\}.$$

For most values of the parameters in the problem, the minimum in (7.22) will be assumed at exactly one point, but if

$$(7.23) \quad A^2 = D_2 D_1 k^2 (k+1)^2$$

for some integer k , then the minimum in (7.22) is achieved at both $l = k$ and $l = k + 1$. In other words, when the partial differential equation first loses stability, it loses stability simultaneously to disturbances of wave number k and of wave number $k + 1$. Such cases provide instances of bifurcation from a double eigenvalue. Even if (7.23) is satisfied approximately but not exactly, we would argue that conclusions based on bifurcation from a simple eigenvalue will be misleading, the presence of a second bifurcation point close by changing the nature of the diagram. We believe this case can be best understood as a perturbation of bifurcation from a double eigenvalue.

The analysis of this problem by the methods of singularity theory will be published elsewhere [12]. It turns out that when (7.23) is satisfied exactly the two-dimensional problem, which results from (7.11) and (7.12) after the Lyapunov-Schmidt reduction, is contact equivalent to one of the canonical forms in (5.6); exactly which problem depends on the parameters A , D_1 , D_2 . Interestingly, four of the five qualitatively different cases illustrated in Figure 5.8 can actually occur in this problem as the parameters are varied.

The axisymmetric buckling of a complete spherical shell (cf. [4]) provides another instance of bifurcation from a double eigenvalue, rather analogous to

the problem considered above. Further instances are documented by Thompson and Hunt, [25], [26].

8. Remarks on the Variational Case

Consider a bifurcation problem in variational form:

$$(8.1) \quad \nabla g(x, \lambda) = 0,$$

where $g : \mathbf{R}^n \times \mathbf{R} \rightarrow \mathbf{R}$ is the germ of a one-parameter family of potential functions and ∇ indicates the gradient with respect to x only. It is a matter of considerable interest to discuss perturbations of (8.1) which themselves have variational form. For example, knowledge of the potential permits a discussion of stability, which is not (yet) possible in the general framework of contact equivalence. Here we sketch an approach to this problem which in fact was the starting point of the present paper. Briefly, all the abstract results of Section 2 and 3 have analogues in the variational case, but the computations of Sections 4 and 5 are much more difficult. Indeed, we have not succeeded in completing any calculation in several dimensions.

We introduce the special notation $f(x) = g(x, 0)$ for the potential function in (8.1) when $\lambda = 0$. We assume that f vanishes to third order at the origin so that $x = 0, \lambda = 0$ is a solution of (8.1) and the Jacobian of (8.1) vanishes there. We suppose that the reader is familiar with various notions from catastrophe theory such as the concept of right equivalence for germs in \mathcal{E}_n . We assume that f has finite codimension relative to right equivalence, that codimension being $\dim \mathcal{M}_n / \langle \partial f / \partial x \rangle$, where $\langle \partial f / \partial x \rangle$ is the ideal generated by the n partial derivatives of f . Let $F_\alpha(x)$, where $\alpha \in \mathbf{R}$, be a universal unfolding of $f(x)$. Let S_F be the universal bifurcation set of F , namely, the l -dimensional submanifold of $\mathbf{R}^n \times \mathbf{R}^l$ defined by

$$S_F = \{(x, \alpha) : \nabla F_\alpha(x) = 0\}.$$

Let $\pi : S_F \rightarrow \mathbf{R}^l$ be the restriction to S_F of the projection onto the second factor in the cross product $\mathbf{R}^n \times \mathbf{R}^l$. The reader may review these ideas in the survey paper [10].

We regard the potential function $g(x, \lambda)$ in (8.1) as a one-parameter unfolding of f . As such g may be factored through the universal unfolding F_α . Thus, for all λ , $g(\cdot, \lambda)$ is right equivalent to $F_{\psi(\lambda)}$, where ψ is some smooth curve $\psi : \mathbf{R} \rightarrow \mathbf{R}^l$. Let $\bar{g}(x, \lambda) = F_{\psi(\lambda)}(x)$. A simple argument shows that (8.1) and $\nabla \bar{g}(x, \lambda) = 0$ are contact equivalent bifurcation problems. Hence it involves no loss of generality to assume that

$$(8.2) \quad g(x, \lambda) = F_{\psi(\lambda)}(x),$$

which we henceforth suppose. Similarly, in considering perturbations of g , say, $g(x, \lambda, \varepsilon)$ where $\varepsilon \in \mathbf{R}^k$, we may suppose without loss of generality that

$$g(x, \lambda, \varepsilon) = F_{\Psi(\lambda, \varepsilon)}(x),$$

where $\Psi : \mathbf{R} \times \mathbf{R}^k \rightarrow \mathbf{R}^l$. In other words, we may represent perturbations of the potential as an unfolding of the curve ψ .

Using these notions and example (5.16), one can prove that there exist nonvariational perturbations of a variational problem which have bifurcation diagrams which are not obtainable by a variational perturbation. Let $g(x, y, \lambda) = \frac{1}{3}x^3 + xy^2 + \lambda(\frac{1}{2}x^2 + \frac{1}{4}y^2)$. Then ∇g is just (5.16) with the second equation multiplied by $\frac{1}{2}$. For this example, $f(x, y) = \frac{1}{3}x^3 + xy^2$, which is Thom's hyperbolic umbilic. The universal unfolding of f is given by $F_\alpha(x, y) = f(x, y) + \frac{1}{2}\alpha_1(x^2 - y^2) + \alpha_2x + \alpha_3y$. One may check that $\text{codim } F_\alpha$ is 0, 1, or 2 if $(x, y, \alpha) \neq 0$. Now recall perturbation P_1 of (5.16). The diagram associated with $G + P_1$ in (5.16) has a bifurcation point at the origin of type $(\text{II})_4$. In two variables this problem has the form $\nabla h = 0$, where $h(x, y, \lambda) = x^2 + y^5 - \frac{1}{2}\lambda y^2$. In particular, a potential function right equivalent to $x^2 + y^5$ must be included in the universal unfolding F_α for some α if the diagram $G + P_1 = 0$ can be realized by a variational perturbation. This is impossible, as the codimension of $x^2 + y^5$ is 3.

We now return to our problem of classifying perturbations of (8.2). To do this we introduce a notion of equivalence for curves in Definition 8.4 below.

DEFINITION 8.3. A diffeomorphism germ $\varphi : (\mathbf{R}^l, 0) \rightarrow (\mathbf{R}^l, 0)$ is called *liftable* (to S_F) if there exists a diffeomorphism germ $\Phi : S_F \rightarrow S_F$ such that $\varphi \circ \pi = \pi \circ \Phi$. Similarly, a vector field w on \mathbf{R}^l is called *liftable* if there is a vector field W on S_F such that $d\pi \cdot W = w$.

Let LD^0 be the identity component of the group of liftable diffeomorphism germs.

DEFINITION 8.4. Two curves $\psi, \bar{\psi} : (\mathbf{R}, 0) \rightarrow (\mathbf{R}^l, 0)$ are *diagram equivalent* if there exists a one-parameter family φ_λ of diffeomorphism germs in LD^0 and an orientation preserving diffeomorphism germ Λ on the line such that

$$\bar{\psi}(\lambda) = \varphi_\lambda \circ \psi \circ \Lambda(\lambda).$$

To get a feeling for this notion of equivalence one should return to the analysis of $(\text{II})_3$ and (III) in Section 4 as well as Figure 4.8. Observe that any liftable diffeomorphism preserves the apparent contour (or critical values) of π which is the cusp curve in Figure 4.8. Then at the very least the number of solutions to $F_{\bar{\psi}(\lambda)}(x) = 0$ for fixed λ is the same as the number of solutions to

$F_{\psi(\Lambda(\lambda))}(x) = 0$. In fact, more is true since we chose the name because it can be shown that if ψ and $\bar{\psi}$ are diagram equivalent and if g, \bar{g} are defined as in (8.2), then the bifurcation diagrams of $\nabla g = 0$ and $\nabla \bar{g} = 0$ can be mapped into one another by a diffeomorphism on $\mathbf{R}^n \times \mathbf{R}$ of the form $(x, \lambda) \mapsto (\rho(x, \lambda), \Lambda(\lambda))$. We suspect that in this case Dg and $D\bar{g}$ are contact equivalent bifurcation problems, but have been unable to prove this. (It is not true that g and \bar{g} are right equivalent.)

The notion of a universal unfolding of a curve ψ relative to diagram equivalence proceeds along standard lines. One considers the orbit $\mathcal{O}_\psi \subset \mathcal{E}_\lambda^1$ of curves equivalent to ψ , computes the tangent space $T\psi$ of the orbit at ψ , and identifies the unfolding parameters with the quotient $\mathcal{E}_\lambda^1/T\psi$ when $T\psi$ has finite codimension. In this case it turns out that

$$T\psi = LV_1(\psi) + \mathcal{E}_\lambda \left\{ \frac{\partial \psi}{\partial \lambda} \right\},$$

where LV_1 is the space of all one-parameter families of liftable vector fields, $LV_1(\psi)$ is the set of one-parameter families of vector fields of the form $W_\lambda(\psi(\lambda))$, where $W \in LV_1$, and $\mathcal{E}_\lambda \{ \partial \psi / \partial \lambda \}$ is the submodule of \mathcal{E}_λ^1 generated by $\partial \psi / \partial \lambda$. Criteria for finite determinacy analogous to Theorems 3.10 and 4.1 are also available in the variational context.

It is generally true that the analytic vector field germs in LV are finitely generated. What makes the computation of $T\psi$ difficult is the enumeration of an explicit set of generators for LV . When this can be done, it is possible to compute the codimension of $T\psi$ (even in the C^∞ category). Arnold [1] has found generators for LV in the one-dimensional case when $f(x) = x^m$ for some integer m . With this representation we have computed unfoldings for all the one-dimensional examples considered in Section 4, obtaining completely analogous results.

Acknowledgments. It is hard to overstate our indebtedness to David Sattinger who originally suggested the application of singularity theory to bifurcation problems and provided encouragement throughout the research. His suggestion to analyze the orbit structure in Section 5 *via* irreducible representations was invaluable. We thank Ed Reiss, Barbara Keyfitz and Arnold Kerr for the time they spent explaining to us what makes sense in applications. Tim Posten, John Mather and Giles Auchmuty have made specific and genuinely helpful additions which are acknowledged in the text. The remarks about degree in Section 5 were stimulated by a conversation with Charles Conley. We are grateful to all of these people.

This work was completed while both authors were visitors at another institution—M. Golubitsky at the Courant Institute and the Institute for Advanced Study and D. Schaeffer at the Mathematics Research Center. The

generous support of these institutions is gratefully acknowledged.

We should also like to thank the Courant Institute for the opportunity to present this material in a seminar course held in the Fall Semester 1977.

Bibliography

- [1] Arnol'd V. I., *Wave front evolution and equivariant Morse lemma*, Commun. Pure Appl. Math. 29, 1976, pp. 557-582.
- [2] Auchmuty, J. F. G., *Qualitative effects of diffusion in chemical systems*, Lectures on Math. in the Life Sciences, to appear.
- [3] Auchmuty, J. F. G., and Nicolis, G., *Bifurcation analysis of nonlinear reaction diffusion equations, I*, Bull. Math. Biol. 37, 1975, pp. 323-365.
- [4] Bauer, L., Reiss, E. L., and Keller, H. B., *Axisymmetric buckling of hollow spheres and hemispheres*, Commun. Pure Appl. Math. 23, 1970, pp. 529-568.
- [5] Benjamin, T. B., *Bifurcation phenomena in steady flows of a viscous fluid*, Part I, Report No. 76, Fluid Mech. Inst., Univ. of Essex, 1976.
- [6] Chow, S., Hale, J., and Mallet-Paret, J., *Applications of generic bifurcation theory, I and II*, Arch. Rat. Mech. Anal. 59, 1975, pp. 159-188 and 209-235.
- [7] Crandall, M., and Rabinowitz, P., *Bifurcation from simple eigenvalues*, J. Func. Anal. 8, 1971, pp. 321-340.
- [8] Saut, J. C., and Temam, R., *Propriétés de l'ensemble des solutions stationnaires ou périodiques des équations de Navier-Stokes* C. R. Acad. Sci. Paris (Ser. A) 285, 1977, pp. 673-676.
- [9] Gavalas, G. R., *Nonlinear Differential Equations of Chemically Reacting Systems*, Springer-Verlag, New York, 1968.
- [10] Golubitsky, M., *An introduction to catastrophe theory and its applications*, SIAM Rev. 20, 1978, pp. 352-387.
- [11] Golubitsky, M., and Guillemin, V., *Stable Mappings and Their Singularities*, GTM14, Springer-Verlag, New York, 1973.
- [12] Golubitsky, M., and Schaeffer, D., *Bifurcation analysis near a double eigenvalue of a model chemical reaction*, submitted to Arch. Rat. Mech.
- [13] Kerr, A. D., and Brantman, R., *On the non-existence of adjacent equilibrium states at bifurcation points*, Acta Mech. 23, 1975, pp. 29-47.
- [14] Lefever, R., and Prigogine, I., *Symmetry breaking instabilities in dissipative systems, II*, J. Chem. Phys. 48, 1968, pp. 1695-1700.
- [15] Martinet, J., *Deploiements versels des applications différentiables et classification des applications stables in Singularités d'Applications Différentiables*, Lecture Notes in Math., No. 535, Springer-Verlag, New York, 1976, pp. 1-44.
- [16] Mather, J., *Stability of C^∞ mappings, III: Finitely determined map germs*, Publ. Math. I.H.E.S. 35, 1968, pp. 127-156.
- [17] Matkowsky, B., and Reiss, E. L., *Singular perturbations of bifurcations*, SIAM J. Appl. Math. 33, 1977, pp. 230-255.
- [18] McLeod, J. B., and Sattinger, D. H., *Loss of stability and bifurcation at a double eigenvalue*, J. Func. Anal. 14, 1973, pp. 62-84.
- [19] Poston, T., and Stewart, I., *Catastrophe Theory and its Applications*, Pitman, San Francisco, 1978.
- [20] Rabinowitz, P., *A Survey of Bifurcation Theory in Dynamical Systems*, Vol. 1, Academic, New York, 1976.
- [21] Ray, W. H., *Bifurcation phenomena in chemically reacting systems*, in *Applications of Bifurcation Theory*, edited by P. Rabinowitz, Academic, New York, 1977, pp. 285-316.
- [22] Serre, J.-P., *Algèbres de Lie Semi-simple Complexes*, W. A. Benjamin, New York, 1966.

- [23] Stoker, J. J., *Non-linear Elasticity*, Gordon and Breach, New York, 1968.
- [24] Thompson, J. M. T., *Bifurcation aspects of catastrophe theory*, Ann. N.Y. Acad. Sci., to appear.
- [25] Thompson, J. M. T., and Hunt, G. W., *A General Theory of Elastic Stability*, Wiley, London, 1973.
- [26] Thompson, J. M. T., and Hunt, G. W., *Towards a unified bifurcation theory*, J. Appl. Math. Phys. 26, 1975, pp. 581–603.
- [27] Wassermann, G., *Stability of unfoldings in space and time*, Acta Math. 135, 1975, pp. 58–128.
- [28] Zeeman, E. C., *Euler buckling in Structural Stability, the Theory of Catastrophes, and Applications in the Sciences*, Lecture Notes in Math., No. 525, Springer-Verlag, New York, 1976, pp. 373–395.

Received April, 1978.